

# **ROLINE Industrial 8-Port Fast Ethernet Switches with Fiber Connectivity**

**21.13.1151 (1ST)**

**21.13.1152 (1SC)**

**21.13.1153 (2ST)**

**21.13.1154 (2SC)**

## **Installation Guide**

The information contained in this document is subject to change without prior notice. Copyright (C). All Rights Reserved.

**WARNING:**

This equipment has been tested and found to comply with the limits for a Class A digital device, pursuant to Part 15 of the FCC Rules. These limits are designed to provide reasonable protection against harmful interference when the equipment is operated in a commercial environment. This equipment generates, uses, and can radiate radio frequency energy and if not installed and used in accordance with the instruction manual may cause harmful interference in which case the user will be required to correct the interference at his own expense.

**NOTICE:**

(1) The changes or modifications not expressly approved by the party responsible for compliance could void the user's authority to operate the equipment.

(2) Shielded interface cables and AC power cord, if any, must be used in order to comply with the emission limits.

CE NOTICE

Marking by the symbol  indicates compliance of this equipment to the EMC directive of the European Community. Such marking is indicative that this equipment meets or exceeds the following technical standards: EN 55022: Limits and Methods of Measurement of Radio Interference characteristics of Information Technology Equipment.

EN 50082/1: Generic Immunity Standard -Part 1: Domestic Commercial and Light Industry.

EN 60555-2: Disturbances in supply systems caused by household appliances and similar electrical equipment - Part 2: Harmonics.

## **1.Introduction**

This series is 8-port full wire speed Fast Ethernet switches for industrial applications. Depending on the fiber connectivity, the series is provided in three types of configuration as follows:

<b>Model series</b>	<b>10/100TX TP Ports</b>	<b>100FX-Fiber Ports</b>
1151/1152	8 x	1 x
1153/1154	8 x	2 x

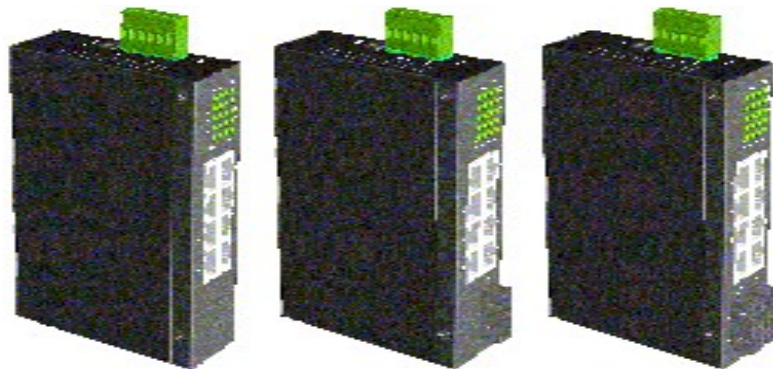

The switches provide the following advantages:

### **Plug and Play**

The switches provide eight 10/100TX copper ports for connections to Ethernet devices or 100Mbps Fast Ethernet devices. With the featured auto-negotiation function, the switches can detect and configure the connection speed and duplex automatically. The switches also provide auto MDI/MDI-X function, which can detect the connected cable and switch the transmission wire pair and receiving pair automatically. This auto-crossover function can simplify the type of network cables used.

### **Selectable Copper/Fiber Connections**

The 100FX fiber ports can support 100Mbps fiber connection using optic fiber cable and extend a network connection up to several kilometers via fiber cables. The 100TX ports are designed to share the same switched ports with the associated 10/100TX copper ports. It means the switched port supports dual network media types, either copper cable or fiber cable.

### **Designed for Industrial Applications**

For industrial environment, the switches are designed with the following enhanced features:

- High and wide operating Temperature
- Wide operating voltage range for DC power input
- Power input interface: Screw terminal block and DC jack for adapter
- Relay output for device power failure alarm
- DIN rail mounting support for industrial enclosure
- Panel mounting support for industrial enclosure

## 1.1 Features

- Fast Ethernet switch with 8 10/100TX copper ports
- Auto MDI/MDI-X detection on all 10/100TX ports
- Auto-negotiation capable on all 10/100TX ports
- 100FX slots support wide range of fiber options
  - ST, SC connectors
  - Multi-mode fiber, Single mode duplex fiber
- Far End Fault function on 100FX ports
- Back pressure flow control for half duplex operation
- IEEE 802.3x flow control for full duplex operation
- Broadcast storm protection function
- Provides comprehensive LED indication
- Support DIN-rail and panel mounting

## 1.2 Product Panels

The following figure illustrates three major panels of this series as example:

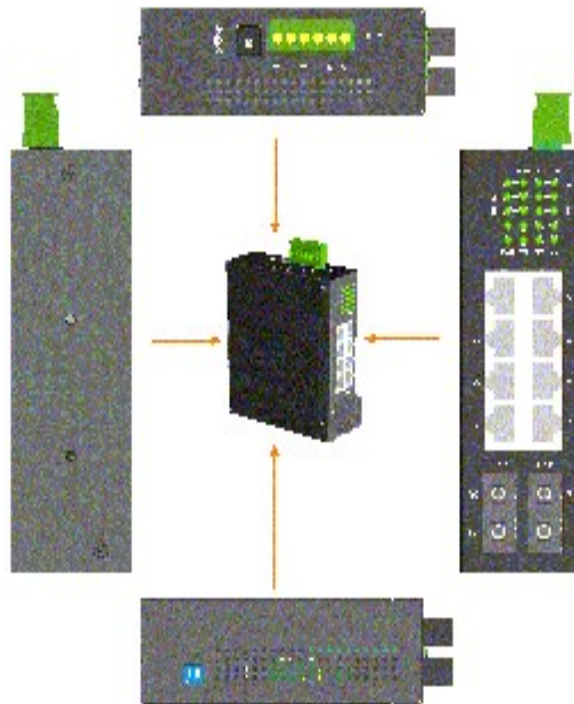

### 1.3 Front Panel

The figure below shows the individual front panel of three model series. The main difference is the number of the equipped fiber ports.

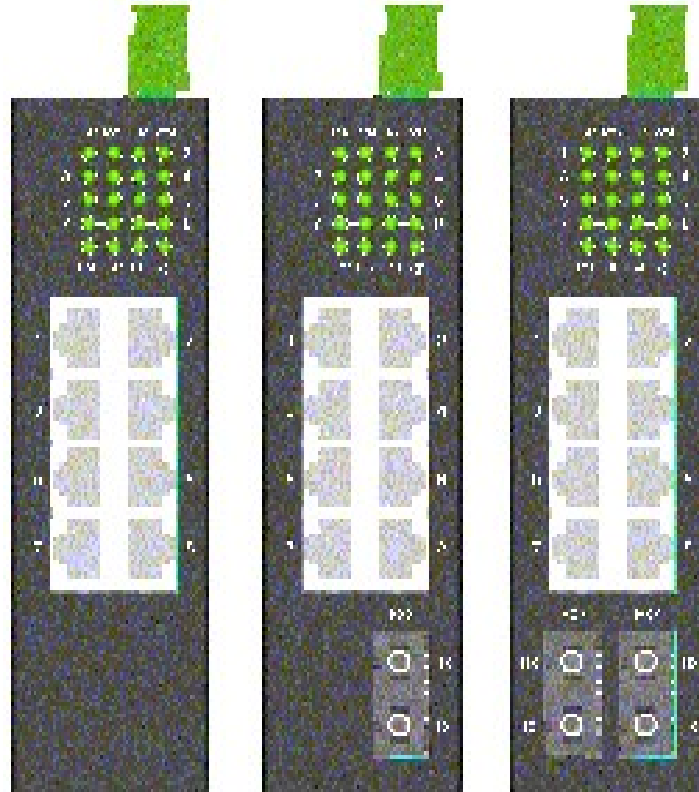

### 1.4 Network Ports

**Model 1150B** provides eight 10/100TX copper ports only. No fiber connectivity is equipped.

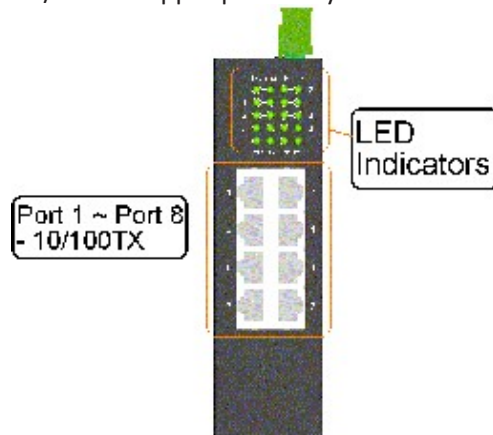

**Model 1151B/1152B** provide eight 10/100TX copper ports and one 100FX fiber connector on Port 8.

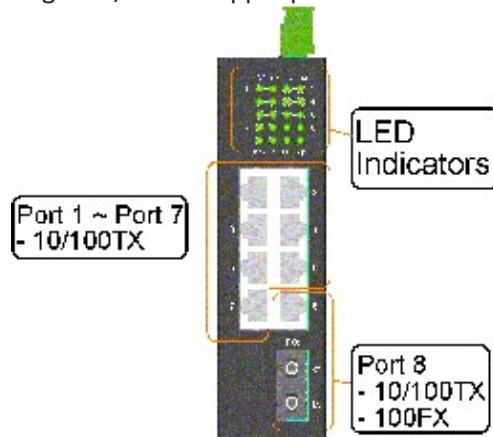

**Model 1153B/1154B series** provide eight 10/100TX copper ports and one 100FX fiber connector on Port 7 and Port 8 respectively.

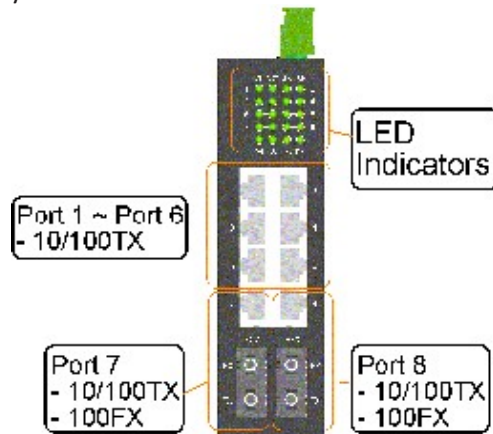

## 1.5 LED Indicators

<b>LED</b>	<b>Function</b>
PWR	Power status
LNK	Network port link status (per port)
100M	Network port speed status (per port)
FX7	Fiber port link status (if fiber port is equipped on Port 7)
FX8	Fiber port link status (if fiber port is equipped on Port 8)
Mgt.	Factory reserved

## 1.6 Top Panel

All three model series provide same top panel as figure shown below:

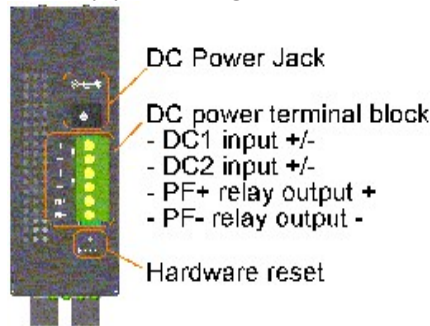

The main functions are:

DC Power Jack	This connector is used when a AC-DC power adapter is used as a power source to the switch.
Terminal Block	This connector provides the following interfaces: DC1 Positive(+) and Negative(-) - VDC power input from power system DC2 Positive(+) and Negative(-) - VDC power cascaded to next device PF Positive(+) and Negative(-) - Power failure relay output
Reset	Hardware reset push button

## 1.7 Bottom Panel

All three model series provide same bottom panel as figure shown below:

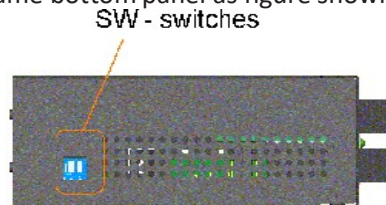

The switch block SW is used for selecting the media connector type for Port 7 and Port 8.

Model	SW	ON Position	OFF Position
1150B	SW1	-	Reserved
	SW2	-	Reserved
1151B/1152B	SW1	-	Reserved
	SW2	Select FX8	Select 10/100TX RJ-45 TP8
1153B/1154B	SW1	Select FX7	Select 10/100TX RJ-45 TP7
	SW2	Select FX8	Select 10/100TX RJ-45 TP8

## 1.8 Specifications

### Network Ports

<u>Switched Port Number</u>	<u>Model 1150B</u>	<u>1151B/1152B</u>	<u>1153B/1154B</u>
Port 1	10/100TX	10/100TX	10/100TX
Port 2	10/100TX	10/100TX	10/100TX
Port 3	10/100TX	10/100TX	10/100TX
Port 4	10/100TX	10/100TX	10/100TX
Port 5	10/100TX	10/100TX	10/100TX
Port 6	10/100TX	10/100TX	10/100TX
Port 7	10/100TX	10/100TX	10/100TX
Port 8	10/100TX	10/100TX 100FX	100FX 10/100TX 100FX

Note: 10/100TX - TP RJ-45, 100FX - Fiber

### 10/100TX Twisted Pair Ports (TP)

Compliance	IEEE 802.3 10BASE-T, IEEE 802.3u 100BASE-TX
Connectors	Shielded RJ-45 jacks
Pin assignments	Auto MDI/MDI-X detection
Configuration	Auto-negotiation
Transmission rate	10Mbps, 100Mbps
Duplex support	Full/Half duplex
Flow control	IEEE 802.3x pause frame base for full duplex operation Back pressure for half duplex operation
Network cable	Cat.5 UTP

### 100FX Fiber Ports

Compliance	IEEE 802.3u 100BASE-FX
Configuration	Forced 100Mbps, Full duplex
Transmission rate	100Mbps
Far end fault function	Capable to receive FEFI (far end fault indication) signal Capable to send FEFI signal when Rx link failure detected
Flow control	IEEE 802.3x pause frame base for full duplex operation Back pressure for half duplex operation
Network cables	MMF 50/125 60/125, SMF 9/125
Eye safety	IEC 825 compliant



### **Switch Functions**

MAC Addresses Table	1K entries
Forwarding & filtering	Non-blocking, full wire speed 10Mbps - 14,880 pps at 64-byte packets 100Mbps - 148,800pps at 64-byte packets
Switching technology	Store and forward
Maximum packet length	1536 bytes
Broadcast storm	64 consecutive broadcast packets in 800ms Protection by dropping broadcast storm packets

### **LED Indicators**

System	Power status
Per 10/100TX port	TP port link/activity status, speed status
Per 100FX port	FX port link status

### **DC Power Input**

Interfaces	Euro type terminal block contacts (DC1 DC2 : 2 sets for power wire cascading) DC Jack ( -D 6.3mm / + D 2.0mm)
Operating Input Voltages	+7V ~ +30V(+5%)
Power consumption	Model 1150B 4.7W/7.5VDC input, 5.0W/30VDC input Model 1151B/1152B 5.3W/7.5VDC input, 5.6W/30VDC input Model 1153B/1154B 7.1W/7.5VDC input, 7.3W/30VDC input

### **Mechanical**

Dimension (base)	140 x 106 x 40 mm
Housing	Enclosed metal with no fan
Mounting	Support DIN-rail mounting, Panel mounting
Weight	Model 1150B 455g, Model 1151B/1152B 465g, Model 1153B/1154B 475g

### **Environmental**

Operating Temperature	Typical -20°C ~ 70°C
Storage Temperature	-20°C ~ 85°C
Relative Humidity	5% ~ 90%

### **Electrical Approvals**

CE	EMC
----	-----

## 1.9 Model Definitions

<b>Model</b>	<b>FX Connectors</b>	<b>Wavelength (nm)</b>	<b>Reference Fiber Distance</b>	<b>Operating Temperature</b>
1151	FX8 : ST MMF	1310	2 km	-10 ~ 70°C
1152	FX8 : SC MMF	1310	2 km	-10 ~ 70°C
1153	FX7 : ST MMF	1310	2 km	-10 ~ 70°C
	FX8 : ST MMF	1310	2 km	-10 ~ 70°C
1154	FX7 : SC MMF	1310	2 km	-10 ~ 70°C
	FX8 : SC MMF	1310	2 km	-10 ~ 70°C

### Optical Specifications

<b>Model</b>	<b>FX Connectors</b>	<b>WaveL. (nm)</b>	<b>TX Power (dBm)</b>	<b>Rx Sens. (dBm)</b>	<b>Rx max. (dBm)</b>
1151B	FX8 : ST MMF	1310	-20 ~ -14	-32 max.	-8 min.
1152B	FX8 : SC MMF	1310	-20 ~ -14	-31 max.	0 min.
1153B	FX7 : ST MMF	1310	-20 ~ -14	-32 max.	-8 min.
	FX8 : ST MMF	1310	-20 ~ -14	-32 max.	-8 min.
1154B	FX7 : SC MMF	1310	-20 ~ -14	-31 max.	0 min.
	FX8 : SC MMF	1310	-20 ~ -14	-31 max.	0 min.

WaveL. : Wavelength, Rx Sens. : Rx sensitivity, Rx max. : Maximum Rx power

## 2. Installation

---

### 2.1 Unpacking

The product package contains:

- The main unit
- One DIN-rail mounting kit
- One CD-ROM

### 2.2 Safety Cautions

To reduce the risk of bodily injury, electrical shock, fire, and damage to the equipment, observe the following precautions.

- Do not service any product except as explained in your system documentation.
- Opening or removing covers may expose you to electrical shock.
- Only a trained service technician should service components inside these compartments.
- If any of the following conditions occur, unplug the product from the electrical outlet and replace the part or contact your trained service provider:
  - The power cable, extension cable, or plug is damaged.
  - An object has fallen into the product.
  - The product has been exposed to water.
  - The product has been dropped or damaged.
  - The product does not operate correctly when you follow the operating instructions.
- Do not push any objects into the openings of your system. Doing so can cause fire or electric shock by shorting out interior components.
- Operate the product only from the type of external power source indicated on the electrical ratings label. If you are not sure of the type of power source required, consult your service provider or local power company.

## 2.3 DIN-Rail Mounting

In the product package, a DIN-rail bracket is provided for mounting the switch in a industrial DIN-rail enclosure.

The steps to mount the switch onto a DIN rail are:

1. Install the mounting bracket onto the switch unit as shown below:

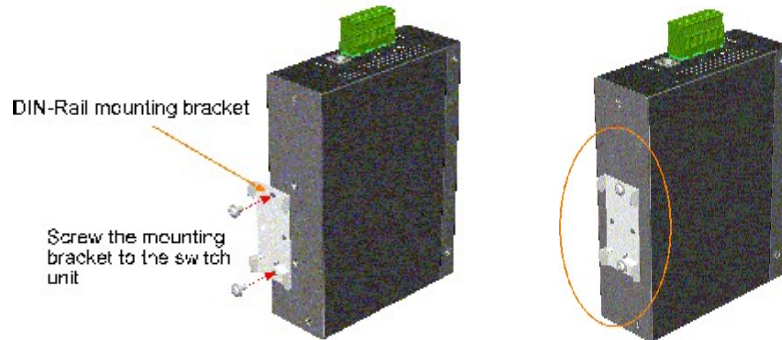

2. Attach bracket to the lower edge of the DIN rail and push the unit upward a little bit until the bracket can clamp on the upper edge of the DIN rail.
3. Clamp the unit to the DIN rail and make sure it is mounted securely.

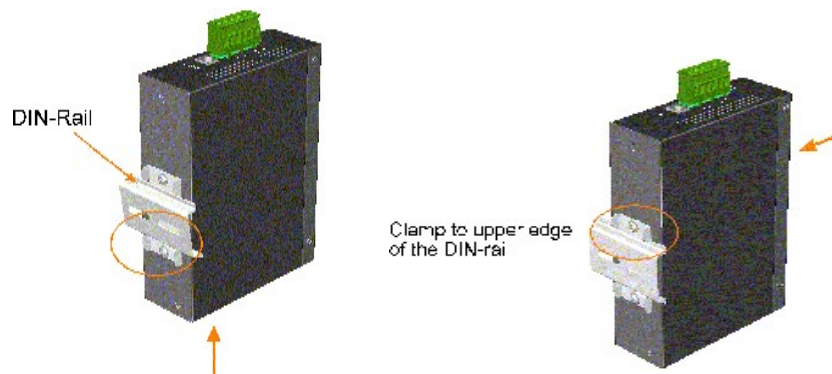

## 2.4 Panel Mounting

The switches are provided with an optional panel mounting bracket. The bracket support mounting the switch on a plane surface securely. The mounting steps are:

1. Install the mounting bracket on the switch unit.

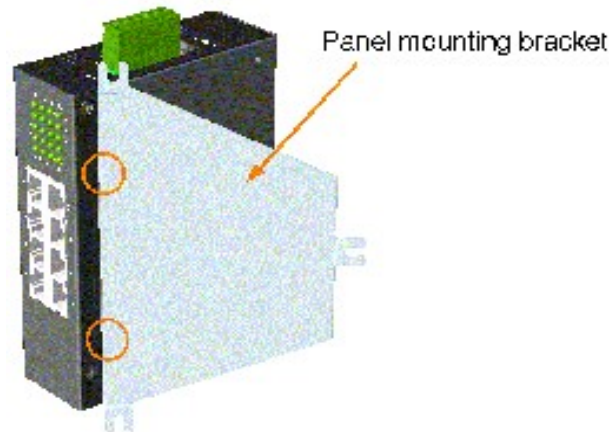

2. Screw the bracket on the switch unit.

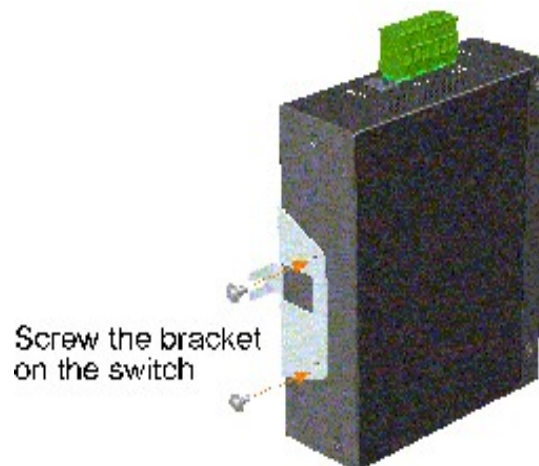

3. Screw the switch unit on a panel. Three screw locations are shown below:

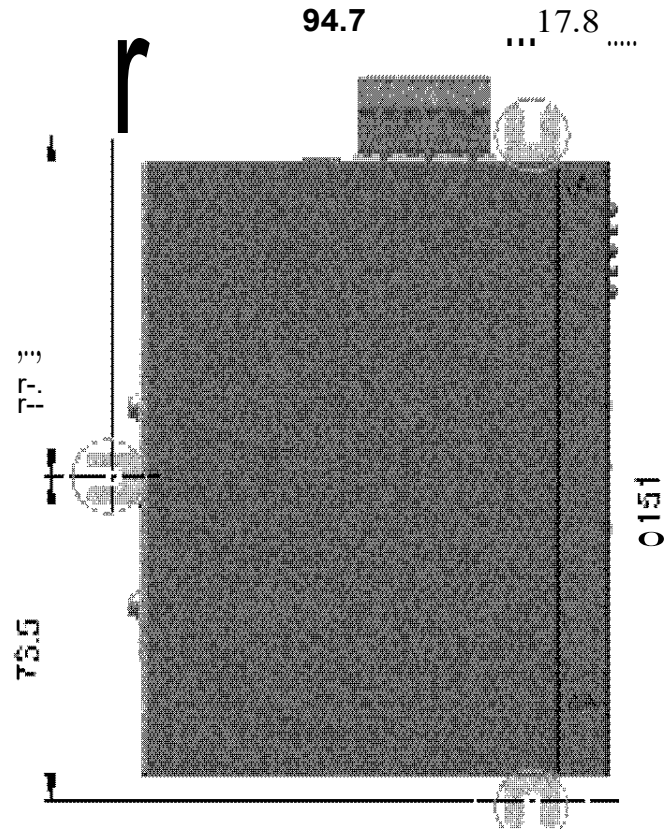

## 2.5 Applying Power

The power specifications of the switch are:

Operating Voltage +7 ~ +30VDC  
Power Consumption Max. 7.3W @30VDC

The switch provides two types of power interfaces, terminal block and DC power jack for receiving DC power input from external power supply.

DC Power Jack 2-pair Terminal blocks DC1 DC2

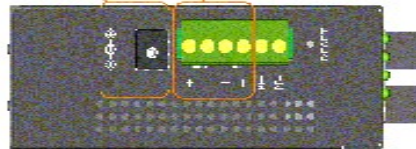

### Using Terminal Blocks

Either DC1 interface or DC2 interface can be used to receive DC power from an external power system. Or, DC2 also can be used to deliver the power received on DC1 to next switch in cascading way.

DC1 + Vdc Positive (+) terminal  
DC1 - Vdc Negative (-) terminal  
DC2 + Vdc Positive (+) terminal  
DC2 - Vdc Negative (-) terminal

Three 2P terminal plugs are provided together with the switch. Two of the three plugs are used for DC1 and DC2 interfaces respectively. The plug is shown below:

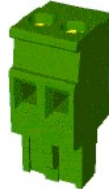

Power wires : 24 ~ 12AWG (IEC 0.5~2.5mm<sup>2</sup>)

Install the power source wires with the plug properly. Then, plug in DC1 contacts. If cascading the power to next switch device is needed, install the power wires and plug for another switch. Then, use DC2 contacts.

*Note: Only up to four device units can be cascaded to receive power from one main power input source.*



### Using DC Power Jack

When an external power system is not available, the switch provides a DC jack to receive power from typical AC-DC power adapter alternatively.



AC Power Adapters: Optional commercial rated adapters are available for purchasing.

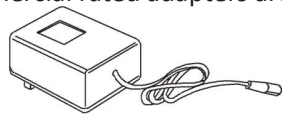

Rated AC120V/60Hz DC7.5V 1A  
Rated AC230V/50Hz DC7.5V 1A  
Rated AC100V/50-60Hz DC7.5V 1A  
Rated AC240V/50Hz DC7.5V 1A

*Note: Before you begin the installation, check the AC voltage of your area. The AC power adapter which is used to supply the DC power for the unit should have the AC voltage matching the commercial power voltage in your area.*

## 2.6 Power Failure Relay Output

The switch provides a relay output to report power failure event to a remote alarm monitoring system. The relay output is provided with two contacts in the terminal block next DC2 interface.

**PF+/- Relay output**

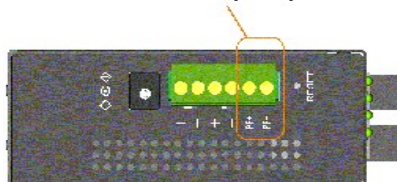

Use the provided 2P terminal plug for signal wiring and plug into the PF+/- contacts. The function is designed as :

Power is normal    PF+ contact is shorted with PF- contact.  
Power failure      PF+ contact is disconnected with PF- contact.

*Note: Be sure the voltage applied on PF+/- contacts is within the specification of 30VDC/1A max. or 120VAC/0.5A max.*

## 2.7 Reset Button

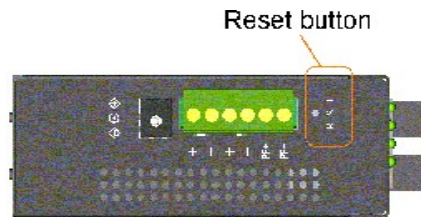

The reset button is used to perform a hardware reset to the switch. It is not used in normal cases and can be used for diagnostic purpose. If any network hanging problem is suspected, it is useful to push the button to reset the switch without turning off the power. Check whether the network is recovered.

## 2.8 Selecting UTP or Fiber

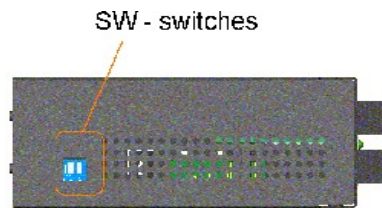

If the switch is equipped with FX7 port or FX8 port, it is required to select the media type to be used for the switched Port 7 and Port 8. Set the setting SW which is located on bottom panel to make the selection.

<b>Model</b>	<b>SW</b>	<b>ON</b>	<b>OFF</b>
1151/1152	SW1	FX8	TP8 (10/100TX RJ-45)
	SW2	-	Reserved
1153/1154	SW1	FX8	TP8 (10/100TX RJ-45)
	SW2	FX7	TP7 (10/100TX RJ-45)

*Note: Do not change the reserved states specified in the above table.*

## 2.9 Making UTP Connections

The 10/100TX ports supports the following connection types and distances:

### Network Cables

10BASE-T: 2-pair UTP Cat. 3,4,5 , EIA/TIA-568B 100-ohm

100BASE-TX: 2-pair UTP Cat. 5, EIA/TIA-568B 100-ohm

Link distance: Up to 100 meters

The ports are equipped with auto MDI/MDI-X function and auto-negotiation function for the UTP connection.

### Auto MDI/MDI-X Function

This function allows the port to auto-detect the twisted-pair signals and adapts itself to form a valid MDI to MDI-X connection with the remote connected device automatically. No matter a straight through cable or crossover cable is connected, the ports can sense the receiving pair automatically and configure itself to match the rule for MDI to MDI-X connection. It simplifies the cable installation.

### Auto-negotiation Function

The ports are featured with auto-negotiation function and full capability to support connection to :

- Auto-negotiation devices
- Auto-negotiation incapable 10BASE-T devices
- Auto-negotiation incapable 100BASE-TX devices

It performs a negotiation process for the speed and duplex configuration with the connected device automatically when each time a link is being established. If the connected device is also auto-negotiation capable, both devices will come out the best configuration after negotiation process. If the connected device is incapable in auto-negotiation, the switch will sense the speed and use half duplex for the connection.

## 2.10 Making Fiber Connections

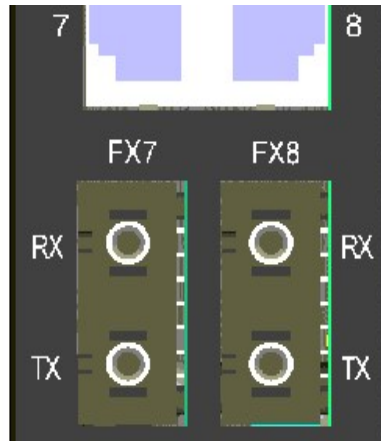

FX7 port and FX8 port operate on 100Mbps and full duplex.

The following figure illustrates a connection example between two fiber ports:

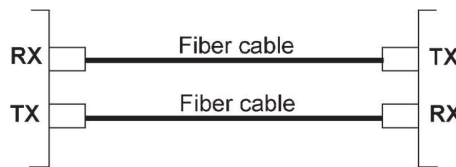

Make sure the Rx-to-Tx connection rule is followed on the both ends of the fiber cable.

### Far End Fault Function

The FX ports are facilitated with this function, which conforms to IEEE 802.3u 100BASE-FX specifications. When the FX port detects a link failure on its receiving circuitry, it will send out an FEFI (Far End Fault Indication) signal to the remote connected device to indicate a remote fault is detected. It also is capable to receive FEFI signal sent from the remote link partner. Upon receiving an FEFI signal, it indicates a link failure occurred on the transmitting path. This function allows the switch to report a fiber link fault even when a link failure occurred on transmitting fiber cable.

1. Detect Rx link failure.



3. FX link fault

3. FX link fault

### Network Cables

Multimode (MMF) - 50/125, 62.5/125

Single mode (SMF) - 9/125

## 2.11 LED Indication

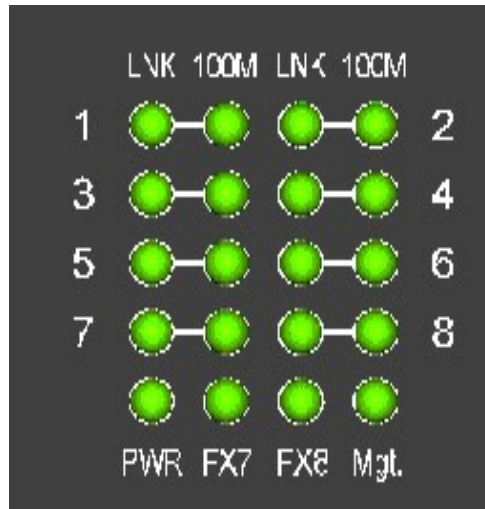

LED	Function	State	Interpretation
PWR	Power status	ON OFF	The power is supplied to the switch. The power is not supplied to the switch.
LNK	Port link status	ON BLINK OFF	An active link is established on the port. (No traffic) Port link is up and there is traffic. Port link is down.
100M	Port speed status	ON OFF	100Mbps 10Mbps
FX7	FX7 link status	ON BLINK OFF	FX7 port is link up. Port link is up and there is traffic. Port link is down.
FX8	FX8 link status	ON BLINK OFF	FX8 port is link up. Port link is up and there is traffic. Port link is down.
Mgt.	Factory Reserved		Ignore the indication.

*Note: FX7 LED is reserved and can be ignored for Model 800 and Model 800-1 series.  
FX8 LED is reserved and can be ignored for Model 800.*