

Preliminary

New S-series wide lineup high resolution network camera with AI engine

5MP Vandal Resistant Indoor Dome Network Camera

Equipped with an AI processor, it can run up to three AI analytics applications (AI apps) simultaneously, which significantly improve the detection rate of people and vehicles and can be used in a wide range of surveillance scenes.

It realizes high-quality and clearer images even in low-light and wide-range shooting scenes.

3 AI Apps operation at same time

- Up to 3 AI apps can be operated at the same time from the wide variety.

Using AI processor which identifies object as people or vehicle, it will reduce false alarm compared to conventional model.

As result, it can be used many industries.

High image quality / High compression

- Our original smart coding technology compatible with H.264 and H.265 delivers high-resolution video at high image quality and low bit rate. Achieved useful images by combining with highly visible images by the intelligent auto (iA) function.

Easy setting and installation

- Easy Kitting Package enabling installers to configure cameras easily while keeping the unit in the box.*

The grommet on the outdoor model can reduce the time and effort required for installation.

User-friendly GUI (setting while watching Live view, etc.) allows you to set comfortably.

iCT tool allows you to set multiple cameras, apps, and recorders all at once, reducing the camera setting time.

*The kitting process should be done within 1hour. The inside of the camera gets hot and may cause a malfunction.

High security

- Equipped with FIPS 140-2 level 3 certified hardware in addition to the digital certificate issued by a third party organization (GlobalSign®).

Key i-PRO Spec.

- 5MP
- Intelligent Auto (with AI Engine)
- Super Dynamic 132dB
- Color night vision (0.12 to 0.17 lx)
- Smart Coding (with AI Engine)
- Built-in IR LED
- IK10 Vandal Resistant
- ONVIF® Profile G / M / S / T
- *ONVIF is a trademark of ONVIF, Inc.
- FIPS 140-2 level3 certified

Industry examples

- Airport (Passport control / Security checkpoint / Ticket counter)
- Retail / Bank / Education / Hospital / Building



Specifications

Camera	Image Sensor	Approx. 1/2.8 type CMOS image sensor	
	Minimum Illumination	Color : 0.12 lx (30IRE, F2.0, 1/30s) *1 Color : 0.17 lx (50IRE, F2.0, 1/30s) BW : 0.1 lx (50IRE, F2.0, 1/30s) BW : 0 lx (50IRE, F2.0, 1/30s with IR LED)	
	White Balance	ATW1 / ATW2 / AWC	
	Shutter Speed	[30fps/15fps mode] 1/30 Fix to 1/10000 Fix [25fps/12.5fps mode] 1/25 Fix to 1/10000 Fix	
	Intelligent Auto	On / Off	
	Super Dynamic*2	On / Off. The level can be set in the range of 0 to 31.	
	Dynamic Range	Max.132 dB (Super Dynamic : On, Level 31)	
	Adaptive Black Stretch	The level can be set in the range of 0 to 255.	
	Back light compensation / High light compensation	BLC (Back light compensation) / HLC (High light compensation) / Off (only when Super dynamic / Intelligent Auto : Off)	
	Fog compensation	On / Off (only when Intelligent auto / auto contrast adjust : Off)	
	Maximum gain (AGC)	The level can be set in the range of 0 to 11.	
	Color/BW (ICR)	Off / On (IR Light Off) / On (IR Light On) / Auto1 (IR Light Off) / Auto2 (IR Light On) / Auto3 (SCC)	
	IR LED Light	High / Middle / Low / Off, Maximum irradiation distance : 25 m (Approx. 82 ft) (30IRE) *1 20 m (Approx. 66 ft) (50IRE)	
	Digital Noise Reduction	The level can be set in the range of 0 to 255.	
	Video Motion Detection (VMD)	On / Off, 4 areas available	
	Scene Change Detection (SCD)	On / Off, 1 areas available	
	Audio Detection	On / Off	
	AI Sound Classification	Gunshot, Yell, Vehicle horn, Glass break	
	AI Analytics	Yes	
	Privacy Zone	On / Off, Up to 8 zones available	
	VIQS	On / Off, Up to 8 zones available	
	Image rotation*3	0 ° / 90 ° / 180 ° / 270 °	
	Camera Title (OSD)	On / Off, Up to 40 characters (alphanumeric characters, marks)	
	Lens	Optical zoom	1x
		Extra zoom	1x - 3x (when resolution is 640 x 360)
		Focal length	3.2 mm (1/8 inches)
		Angular Field of View	[16:9 mode] Horizontal : 95°, Vertical : 52° [4:3 mode] Horizontal : 95°, Vertical : 70°
		Maximum Aperture Ratio	1 : 2.0
DORI	Focus range	1.0 m {39-3/8 inches} ~ ∞	
	Detect (25ppm / 8ppf)	56.3 m / 184.7 ft	
	Observe (62.5ppm / 19ppf)	22.5 m / 73.9 ft	
	Recognize (125ppm / 38ppf)	11.3 m / 36.9 ft	
Identify (250ppm / 76ppf)	5.6 m / 18.5 ft		
System on Chip (SoC)		Amarella CV22	
Adjusting Angle		Horizontal : -240 to +120°, Vertical : -30 to +85°, Yaw : ±100°	
Browser GUI	Camera Control	Brightness, AUX On / Off	
	Audio	Mic (Line) Input : On / Off Volume adjustment : Low / Middle / High Audio Output : On / Off Volume adjustment : Low / Middle / High	
	GUI / Setup Menu Language	English, Italian, French, German, Spanish, Portuguese, Russian, Chinese, Japanese	
	Browser *4	Microsoft Edge, Firefox, Google Chrome	
Network	Network IF	10Base-T / 100Base-TX, RJ45 connector	
	Resolution	[16:9 mode (30 fps mode)] [16:9 mode (25 fps mode)] 3072x1728/2560x1440/1920x1080/1280x720/640x360/320x180 [4:3 mode (30 fps mode)] [4:3 mode (25 fps mode)] 3072x2304/2560x1920/1280x960/800x600/VGA/400x300/320x240	
	H.265/ H.264/ JPEG (MJPEG)		
	H.265/ Transmission Mode	Constant bit rate / VBR / Frame rate / Best effort	
	H.264 *6 Transmission Type	Unicast port (AUTO) / Unicast port (MANUAL) / Multicast	
	JPEG Image Quality	10 steps	
	Smart Coding	GOP (Group of pictures) control: Off/ Low (Variable GOP 1s-8s) / Mid (Variable GOP 4s-16s) / Advanced(Fixed GOP 60s w/1s key-frame) / Frame rate control (Variable GOP 4s-16s with frame rate control) *Advanced and Frame rate control are only available with H.265. Smart VIQS: On(High)/On(Low)/Off. Smart P-picture control: On/Off	

Network	Audio Compression	G.726 (ADPCM) : 16 kbps / 32 kbps G.711 : 64 kbps AAC-LC*7 : 64 kbps / 96 kbps / 128 kbps	
	Audio transmission mode	Off / Mic (Line) input / Audio output / Interactive (Half duplex) / Interactive (Full duplex)	
	Supported Protocol	IPv6: TCP/IP, UDP/IP, HTTP, HTTPS, SSL/TLS, SMTP, DNS, NTP, SNMPv1/v2/v3, DHCPv6, RTP, MLD, ICMP, ARP, IEEE 802.1X, DiffServ, SFTP, MQTT, LLDP IPv4: TCP/IP, UDP/IP, HTTP, HTTPS, SSL/TLS, RTSP, RTP, RTSP/RTCP, SMTP, DHCP, DNS, DDNS, NTP, SNMPv1/v2/v3, UPnP, IGMP, ICMP, ARP, IEEE 802.1X, DiffServ, SRTP, SFTP, MQTT, LLDP	
	No. of Simultaneous Users	Up to 14 users (Depends on network conditions)	
	Secure	FIPS 140-2 level3	
	SDXC/SDHC/SD Memory Card	H.265 / H.264 recording : Manual REC / Alarm REC (Pre/Post) / Schedule REC / Backup upon network failure JPEG recording : Manual REC / Alarm REC (Pre/Post) / Backup upon network failure Compatible SDXC/SDHC/SD Memory Card : microSDXC memory card: 64 GB, 128 GB, 256 GB, 512 GB microSDHC memory card: 4 GB, 8 GB, 16 GB, 32 GB microSD memory card: 2 GB	
	Mobile Terminal Compatibility	iPad, iPhone(iOS 8.0 or later), Android™ terminals	
	ONVIF® Profile	G / M / S / T	
	Alarm	Alarm Source	3 terminals input, VMD alarm, Command alarm, Audio detection alarm
		Alarm Actions	SDXC/SDHC/SD memory recording, E-mail notification, HTTP alarm notification indication on browser, TCP alarm notification output
Input/ Output		Monitor Output (for adjustment)	VBS : 1.0 V [p-p] / 75 Ω, composite, Pin jack An NTSC or PAL signal can be outputted from camera
	Audio input	ø3.5 mm stereo mini jack For microphone input : Recommended applicable microphone : Plug-in power type (Sensitivity of microphone : -51 dB to -38 dB (0 dB=1 V/Pa, 1 kHz)) Input impedance : Approx. 2 kΩ (unbalanced) Supply voltage : 2.5 V ±0.5 V	
		For line input : Input level : Approx. -10 dBV	
	Audio Output	ø3.5 mm stereo mini jack (monaural output) Output impedance : Approx. 600 Ω (unbalanced) Output level : -20 dBV	
	External I/O Terminals	ALARM IN 1 (Alarm input 1/ Black & white input/ Auto time adjustment input) (x1) ALARM IN 2 (Alarm input 2/ ALARM OUT) (x1) ALARM IN 3 (Alarm input 3/ AUX OUT) (x1)	
General	Safety	UL (UL62368-1), c-UL (CSA C22.2 No.62368-1), CE, IEC62368-1	
	EMC	FCC (Part15 ClassA), ICES-003 ClassA, EN55032 ClassA, EN55035	
	Power Source and Power Consumption	DC power supply : DC12 V 880 mA, Approx. 10.6 W PoE (IEEE802.3af compliant) Device : DC48 V 220 mA, Approx. 10.6 W (Class 0 device)	
	Ambient Operating Temperature	-10 °C to +50 °C (14 °F to 122 °F) (Power On range: 0 °C to 50 °C (32°F to 122 °F))	
	Shock Resistance	IK10 (IEC 62262)	
	Ambient Operating Humidity	10 to 90 % (no condensation)	
	Dimensions	ø129.5 mm x 102.5 mm (H) {ø5-3/32 inches x 4-1/32 inches (H)} Dome radius 41.5 mm {1-5/8 inches}	
	Mass (approx.)	800 g {1.77 lbs.}	
	Finish	Main body : Aluminum die cast, i-PRO white Outer fixing screws : Stainless steel (Corrosion-resistant treatment) Dome cover : Polycarbonate resin, Clear	

*1 Converted value
*2 When 60 fps or 50 fps is selected, the Super Dynamic function is automatically set to off.
*3 When the 60 fps mode, 50 fps mode, 15 fps mode or 12.5 fps mode is used, the "90°" and "270°" settings are not available.
When the 320x180 resolution is used, the "90°" and "270°" settings are not available.
*4 For information on the operation verification of the supported web browsers, refer to our support website <Control No.: C0132>.
*5 Used by super resolution techniques.
*6 Transmission for 4 streams can be individually set.
*7 When recording audio on an microSD memory card, only use AAC-LC (Advanced Audio Coding - Low Complexity).

Appearance

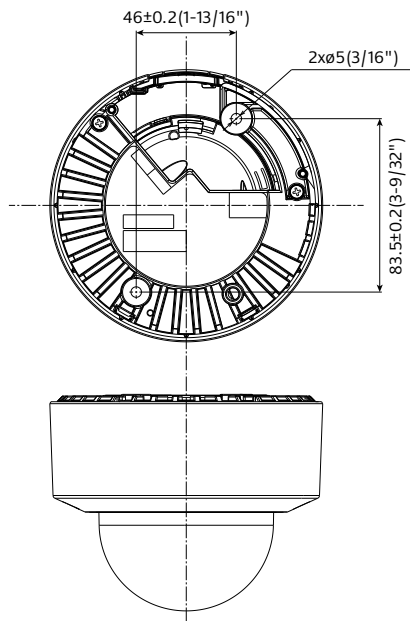
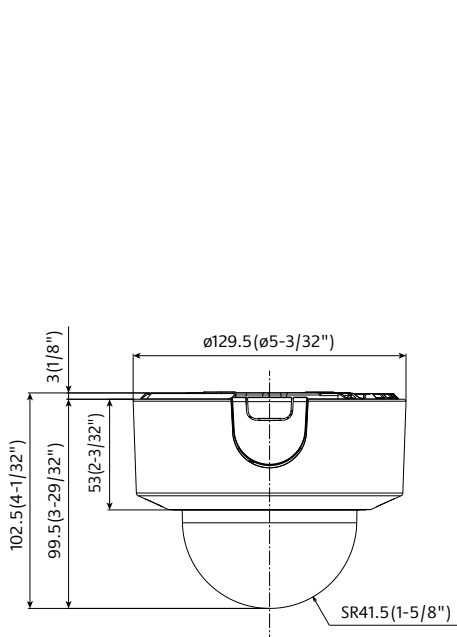

Unit : mm (inches)

AI Analytics applications

<https://i-pro.com/global/en/surveillance/products/i-pro-ai-application>

AI Video Motion Detection (AI-VMD)

Advanced video analysis technology detects objects (faces, people, cars, motorcycles) in a specified area. (Intruder Detection, Loitering Detection, Direction Detection, Cross Line Detection)

AI Privacy Guard

To protect privacy and portrait rights, it is possible to automatically apply a mosaic the entire face and figure of a person photographed by the camera.

AI Face Detection

Detects faces with high precision even in low-light, backlit, and mask-wearing environments.

AI People Detection

Extract the characteristics of human face / clothing and classify them into meaningful categories such as gender, age, and clothing color.

AI Vehicle Detection

Extract vehicle characteristics and classify them into meaningful categories such as type and color.

AI Non mask Detection

Deep-learning and proprietary image processing technologies recognize mask and detect people who are not wearing them.

AI Occupancy Detection











Detecting the congestion via network camera with AI engine enables that information to be used direct visitors in advance or help store staff work more efficiently.

3rd party applications are also available.





<https://i-pro.com/global/en/surveillance/i-pro-application-platform/application-list>

Optional Accessories

Mount Bracket / Other

combination	WALL		POLE	CORNER	HANGING	
	1	2	1	1	1	2
	Wall Mount Bracket WV-QWL501-W (i-PRO white) 	Wall Mount Bracket WV-QWL500-W (i-PRO white) 	Pole Mount Bracket WV-QPL500-W (i-PRO white) 	Corner Mount Bracket WV-QCN500-W (i-PRO white) 	Ceiling Mount Bracket WV-QCL501-W (i-PRO white) 	Ceiling Mount Bracket WV-QCL100-W *1 (i-PRO white) 
	Mount Bracket WV-QSR501-W (i-PRO white) 	Adapter Box WV-QJB500-W (i-PRO white)  *If needed.	Wall Mount Bracket WV-QWL500-W (i-PRO white) (+ WV-QJB500-W) 	Wall Mount Bracket WV-QWL500-W (i-PRO white) (+ WV-QJB500-W) 	Mount Bracket WV-QSR501-W (i-PRO white) 	3rd parties pipe

*1: It's possible to be used on the camera side and ceiling side. If used on both side, 2pieces are required.

combination	CEILING		OTHER
	1	2	1
	Ceiling Mount Bracket (Embedded) WV-QEM100-W (i-PRO white) 	Ceiling Mount Bracket WV-Q105A 	Attachment pipe (For 3rd party bracket) WV-QAT500-W (i-PRO white) 
	/		Mount Bracket WV-QSR501-W (i-PRO white) 
			3rd parties pipe

Dome Cover

Dome Cover (Smoke type)
WV-CR1S



Trademarks and registered trademarks

- GlobalSign and the GlobalSign Logo are registered trademarks of GMO GlobalSign K.K.
- iPad and iPhone are trademarks of Apple Inc., registered in the U.S. and other countries.
- Android is a trademark of Google LLC.
- ONVIF is a trademark of ONVIF, Inc.
- All other trademarks identified herein are the property of their respective owners.

Important

- Safety Precautions : Carefully read the Basic Information, Installation Guide and Operating Instructions before using this product.
- i-PRO Co., Ltd. cannot be held responsible for the performance of the network and/or other manufacturers' products used on the network.
- Masses and dimensions are approximate. • Specifications are subject to change without notice.