

20800-168 INTERMEDIATE ADAPTER TO ASSEMBLE SEVERAL 3 U TESTADAPTERS, 6 U, 220 MM, 350 MM

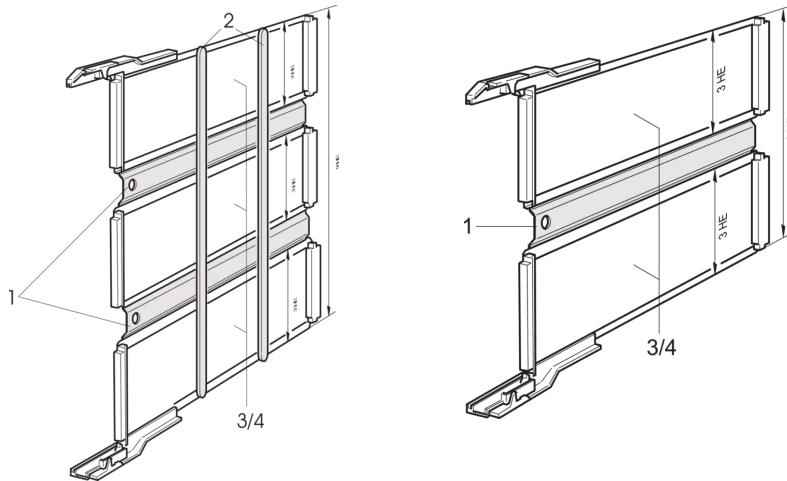

KEY FEATURES

Suitable for types B, C, D, E, F

PRODUCT ATTRIBUTES

Product Type: Adapter

Works With: Test Adapters

ADDITIONAL PRODUCT DETAILS

Bracket kit to make a 6 / 9 U Testadapter from 3 U Testadapters. Suitable for Testadapters with DIN 41612 connectors Type B, C, E and F.

Test adaptor for DIN connector type D cannot be combined with other types.

Test adaptor depth (dimension B) of VMEbus test adaptors on corresponding product page.

Test adaptor depth (dimension B) of type B, C, D, E, F test adaptors on corresponding product page.



North America

All locations
+1.763.422.2661
Chat with us:
schroff.nvent.com

Europe

Straubenhardt, Germany
+49.7082.794.0
Betschdorf, France
+33.3.88.90.64.90
Warsaw, Poland
+48.22.209.98.35
Assago, Italy
+39.02.932.7141
Chat with us:
schroff.nvent.com

Asia

Shanghai, China
+86.21.2412.6943
Qingdao, China
+86.532.8771.6101
Singapore
+65.6768.5800
Shin-Yokohama, Japan
+81.45.476.0271
Chat with us:
schroff.nvent.com

Middle East & India

Dubai, United Arab Emirates
+971.4.378.1700
Bangalore, India
+91.80.6715.2001
Istanbul, Turkey
+90.216.250.7374
Chat with us:
schroff.nvent.com



Our powerful portfolio of brands:
nVent.com **CADDY ERICO HOFFMAN RAYCHEM SCHROFF TRACER**