

21130-445 VARISTAR 19" SWING CABINET FRAME TRIM, 38 U SYMMETRICAL ASSEMBLY

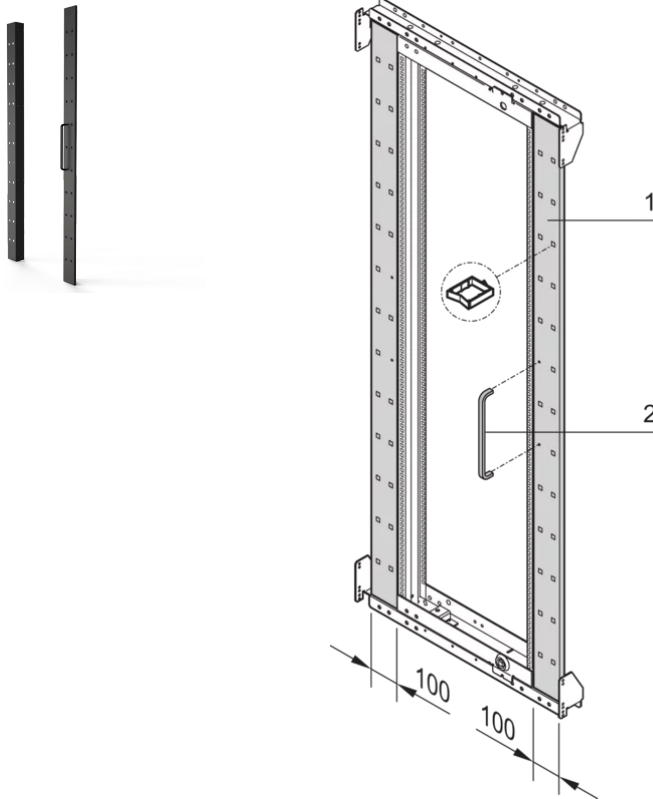

KEY FEATURES

Includes handle and cut-out for cable eyes

To cover the gap between swing frame and cabinet upright for 800 mm wide cabinets

Max. swing bracket: 120 or 160

For swing frame with load-carrying capacity 150 kg, a stop is recommended for security reasons

Locking no. 333

Spare key for DIN semi-profile cylinder

PRODUCT ATTRIBUTES

Product Type: Cabinet/Rack Frame

Product Family: Varistar

Type: Swing

Frame Material: Steel

Color: Black Grey

Color Code: RAL 7021

Rack Height: 38 U

Width: 800 mm

ADDITIONAL PRODUCT DETAILS

Varistar swing frame provides optimum space usage inside the rack. The swing frames come with handles.

CERTIFICATIONS



North America

All locations
+1.763.422.2661
Chat with us:
schroff.nvent.com

Europe

Straubenhardt, Germany
+49.7082.794.0
Betschdorf, France
+33.3.88.90.64.90
Warsaw, Poland
+48.22.209.98.35
Assago, Italy
+39.02.932.7141
Chat with us:
schroff.nvent.com

Asia

Shanghai, China
+86.21.2412.6943
Qingdao, China
+86.532.8771.6101
Singapore
+65.6768.5800
Shin-Yokohama, Japan
+81.45.476.0271
Chat with us:
schroff.nvent.com

Middle East & India

Dubai, United Arab Emirates
+971.4.378.1700
Bangalore, India
+91.80.6715.2001
Istanbul, Turkey
+90.216.250.7374
Chat with us:
schroff.nvent.com



Our powerful portfolio of brands:
nVent.com **CADDY ERICO HOFFMAN RAYCHEM SCHROFF TRACER**

© 2023 nVent. All nVent marks and logos are owned or licensed by nVent Services GmbH or its affiliates. All other trademarks are the property of their respective owners.

nVent reserves the right to change specifications without notice.