

21130-478 VARISTAR CONNECTION PLATE FOR SHORTENED DOOR/REAR PANEL, WITH BRUSH STRIP, RAL 7021, 400H 600W

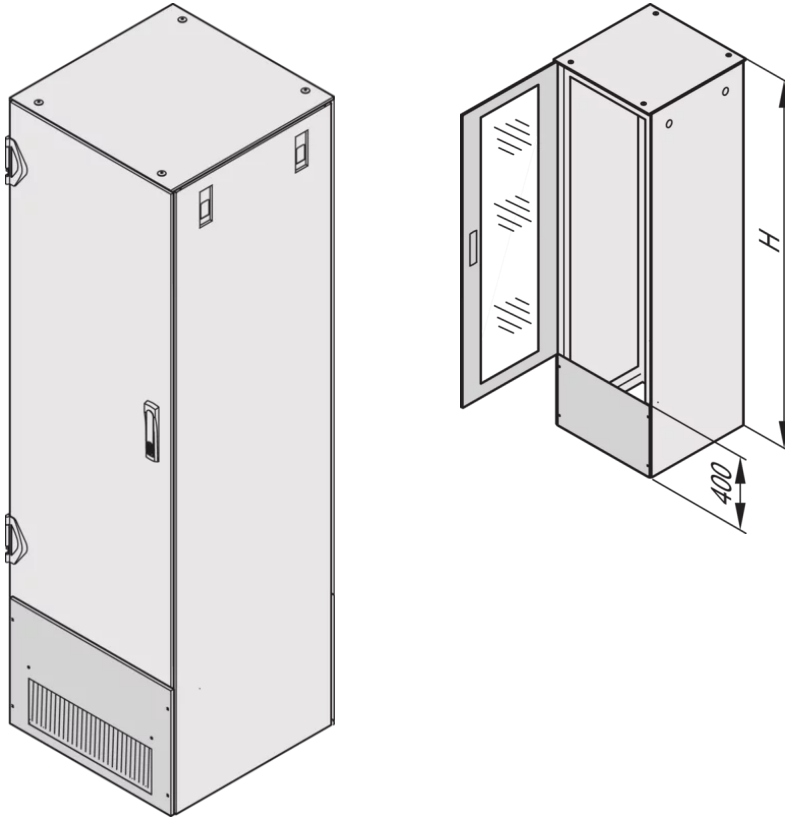

KEY FEATURES

Used for shortened door and rear panel

Height 400 mm

Plain or with brush strip

St, 1 mm

Can also be fitted at top or bottom

Connecting plate for door and rear panel

PRODUCT ATTRIBUTES

Product Type: Cabinet/Rack Panel

Product Family: Varistar

Type: Filler Panel

Color: Black Grey

Color Code: RAL 7021

Height: 400 mm

Width: 600 mm

ADDITIONAL PRODUCT DETAILS

Varistar Connection Plate for shortened Door/Rear Panel for IP 20.

The height of the door and rear panel must be chosen to be 400-mm less than the cabinet height.

Connecting plate cannot be used with double door.

CERTIFICATIONS



North America

All locations

+1.763.422.2661

Chat with us:

schroff.nvent.com

Europe

Straubenhardt, Germany

+49.7082.794.0

Betschdorf, France

+33.3.88.90.64.90

Warsaw, Poland

+48.22.209.98.35

Assago, Italy

+39.02.932.7141

Chat with us:

schroff.nvent.com

Asia

Shanghai, China

+86.21.2412.6943

Qingdao, China

+86.532.8771.6101

Singapore

+65.6768.5800

Shin-Yokohama, Japan

+81.45.476.0271

Chat with us:

schroff.nvent.com

Middle East & India

Dubai, United Arab Emirates

+971.4.378.1700

Bangalore, India

+91.80.6715.2001

Istanbul, Turkey

+90.216.250.7374

Chat with us:

schroff.nvent.com



Our powerful portfolio of brands:
nVent.com **CADDY ERICO HOFFMAN RAYCHEM SCHROFF TRACER**

© 2023 nVent. All nVent marks and logos are owned or licensed by nVent Services GmbH or its affiliates. All other trademarks are the property of their respective owners.

nVent reserves the right to change specifications without notice.