

23130-031 VARISTAR 19" PANEL/SLIDE MOUNT, ALZN, 1200H

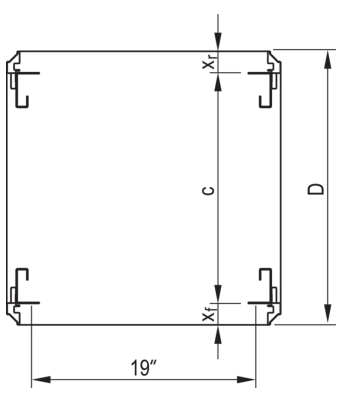
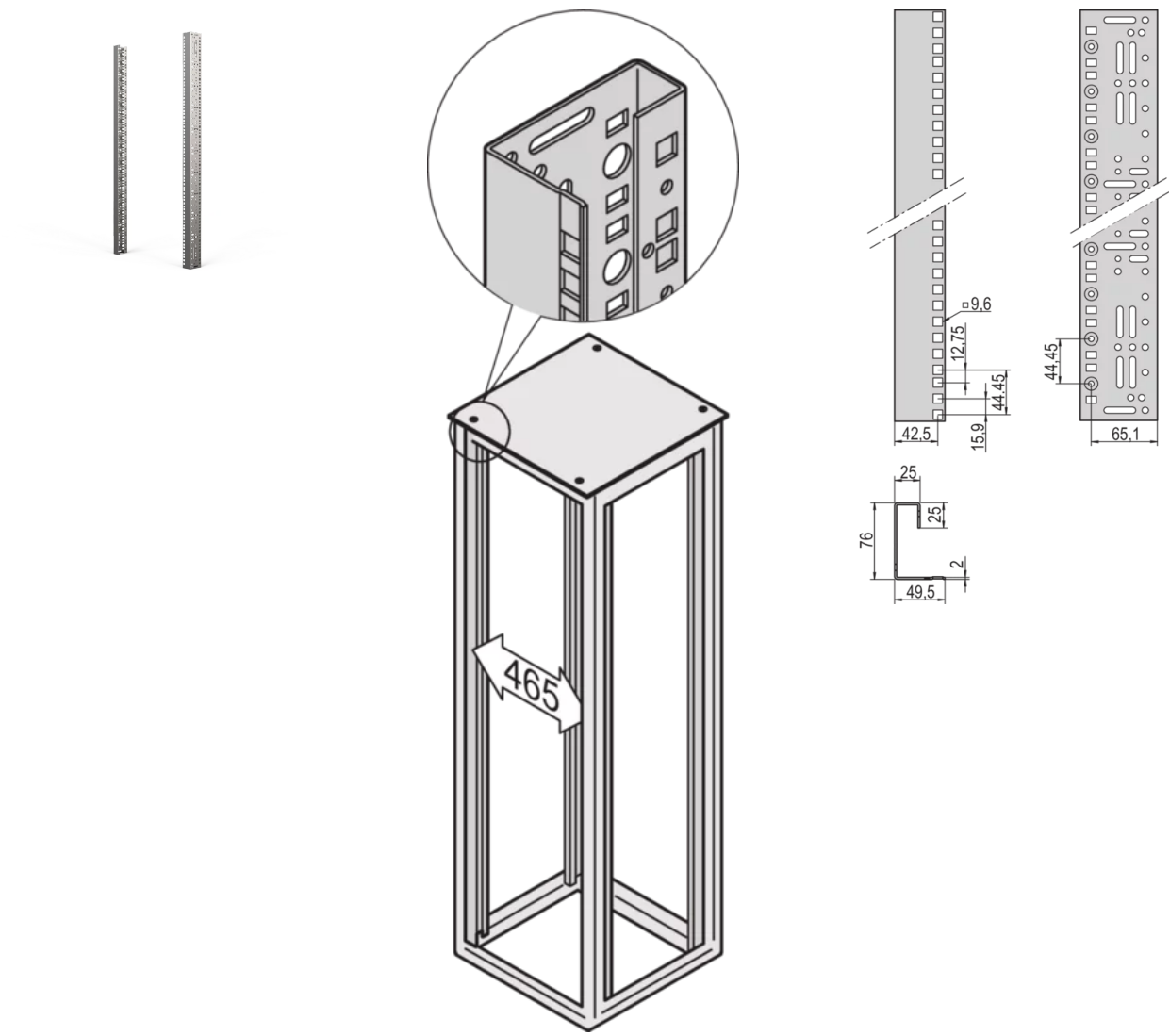

KEY FEATURES

Depth-adjustable in 25 mm increments

In accordance with IEC-60297-1 (DIN-41-494, Part-1)

Assembly in 600 mm wide cabinets directly on the frame

St, 2 mm, at 800 mm width adapter bracket for reduced width is necessary, for partial-height mounting depth members are necessary

Dimensions are printed in U increments (1 ... 47 U)

Subsequent assembly possible

PRODUCT ATTRIBUTES

Product Type: Slide Mount

Product Family: Varistar

Material: Steel

Finish: Aluminum-Zinc Plated

Rack Height: 24 U

Height: 1200 mm

Length: 1095 mm

Package Quantity: 1

Package Unit: Pair

ADDITIONAL PRODUCT DETAILS

Slide mount with adjustable increments.

For 19" partial-height mounting depth members are necessary.

Metric panel/slide mounts available on request.

CERTIFICATIONS



North America

All locations

+1.763.422.2661

Chat with us:

schroff.nvent.com

Europe

Straubenhardt, Germany

+49.7082.794.0

Betschdorf, France

+33.3.88.90.64.90

Warsaw, Poland

+48.22.209.98.35

Assago, Italy

+39.02.932.7141

Chat with us:

schroff.nvent.com

Asia

Shanghai, China

+86.21.2412.6943

Qingdao, China

+86.532.8771.6101

Singapore

+65.6768.5800

Shin-Yokohama, Japan

+81.45.476.0271

Chat with us:

schroff.nvent.com

Middle East & India

Dubai, United Arab Emirates

+971.4.378.1700

Bangalore, India

+91.80.6715.2001

Istanbul, Turkey

+90.216.250.7374

Chat with us:

schroff.nvent.com



Our powerful portfolio of brands:
nVent.com **CADDY ERICO HOFFMAN RAYCHEM SCHROFF TRACER**

© 2023 nVent. All nVent marks and logos are owned or licensed by nVent Services GmbH or its affiliates. All other trademarks are the property of their respective owners.

nVent reserves the right to change specifications without notice.