

23130-215 VARISTAR MOBILE BASE/PLINTH, 800W 1000D

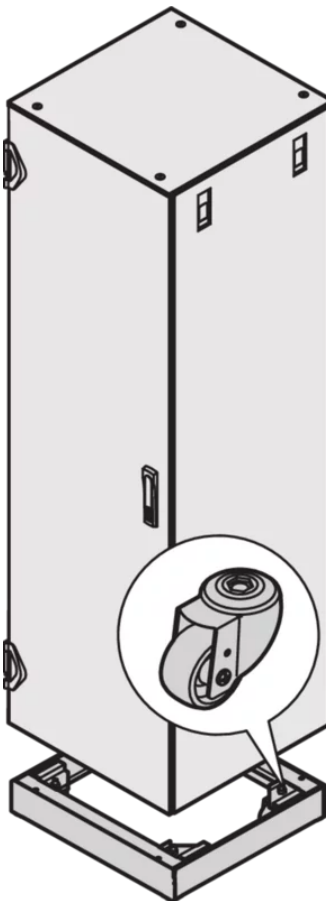
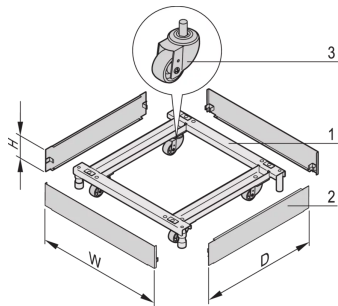

KEY FEATURES

Covers, St, 1.5 mm

Load-carrying capacity on casters 400-kg, on adjustable feet 1000 kg

Support, St, 3 mm

Color RAL 7021

Plinth height H = 100 mm, with feet adjustable from 126-to 134-mm

PRODUCT ATTRIBUTES

Product Type: Cabinet/Rack Base

Product Family: Varistar

Type: Base Plinth, Mobile

Color: Black Grey

Color Code: RAL 7021

Width: 800 mm

Depth: 1000 mm

ADDITIONAL PRODUCT DETAILS

Mobile base/plinth to make a cabinet mobile.

CERTIFICATIONS



North America

All locations

+1.763.422.2661

Chat with us:

schroff.nvent.com

Europe

Straubenhardt, Germany

+49.7082.794.0

Betschdorf, France

+33.3.88.90.64.90

Warsaw, Poland

+48.22.209.98.35

Assago, Italy

+39.02.932.7141

Chat with us:

schroff.nvent.com

Asia

Shanghai, China

+86.21.2412.6943

Qingdao, China

+86.532.8771.6101

Singapore

+65.6768.5800

Shin-Yokohama, Japan

+81.45.476.0271

Chat with us:

schroff.nvent.com

Middle East & India

Dubai, United Arab Emirates

+971.4.378.1700

Bangalore, India

+91.80.6715.2001

Istanbul, Turkey

+90.216.250.7374

Chat with us:

schroff.nvent.com



Our powerful portfolio of brands:
nVent.com **CADDY ERICO HOFFMAN RAYCHEM SCHROFF TRACER**

© 2023 nVent. All nVent marks and logos are owned or licensed by nVent Services GmbH or its affiliates. All other trademarks are the property of their respective owners.

nVent reserves the right to change specifications without notice.