

24560-053 EUROPACPRO COVER PLATE, UNIVERSAL, 84 HP, 295 MM

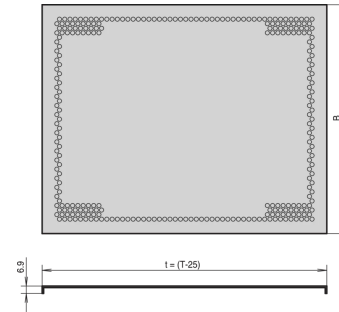
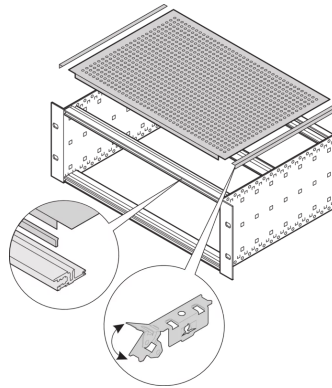
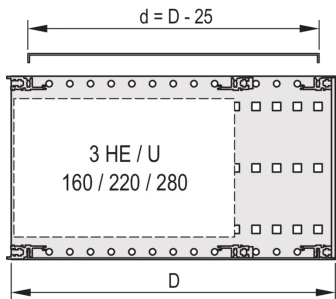

KEY FEATURES

Shielding is provided by optional EMC stainless steel gaskets, between cover plate and side panel

For variable positioning of horizontal rails e.g. for PCBs with non-standard formats

Perforation degree 58%

Suitable for use with all horizontal rails

PRODUCT ATTRIBUTES

Product Type: Cover Plate

Product Family: EuropacPRO

Type: Universal

Rack Width: 84 HP

Depth: 295 mm

Package Quantity: 1

Package Unit: Pair

ADDITIONAL PRODUCT DETAILS

A cover plate is used for electromagnetic shielding or as mechanical protection. The cover can be used is non-standard boards will be assembled into the subrack.

In addition, 4 contact strips per subrack are required to affix cover to horizontal rail.



North America

All locations
+1.763.422.2661
Chat with us:
schroff.nvent.com

Europe

Straubenhardt, Germany
+49.7082.794.0
Betschdorf, France
+33.3.88.90.64.90
Warsaw, Poland
+48.22.209.98.35
Assago, Italy
+39.02.932.7141
Chat with us:
schroff.nvent.com

Asia

Shanghai, China
+86.21.2412.6943
Qingdao, China
+86.532.8771.6101
Singapore
+65.6768.5800
Shin-Yokohama, Japan
+81.45.476.0271
Chat with us:
schroff.nvent.com

Middle East & India

Dubai, United Arab Emirates
+971.4.378.1700
Bangalore, India
+91.80.6715.2001
Istanbul, Turkey
+90.216.250.7374
Chat with us:
schroff.nvent.com



Our powerful portfolio of brands:
nVent.com **CADDY ERICO HOFFMAN RAYCHEM SCHROFF TRACER**