

24562-457 C-PROFILE ADAPTOR FOR SUBRACKS ASSEMBLED INTO CABINETS, 415 MM

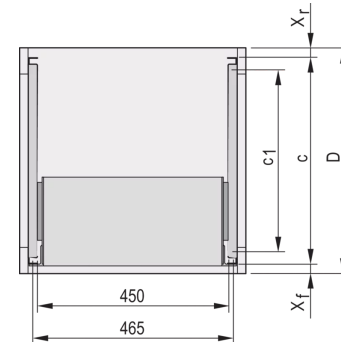
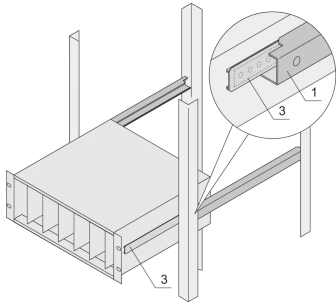

KEY FEATURES

The C-profile fixes the subrack on the guiding profile when mounted into a cabinet.

PRODUCT ATTRIBUTES

Product Type: Telescopic Slide

Product Family: EuropacPRO

Works With: Subracks

Depth: 415 mm

Package Quantity: 2

ADDITIONAL PRODUCT DETAILS

The C-profile, assembled on the Side Panel of the subrack serves fixes the subrack on the guiding profile when mounted into a cabinet.

Note: No end stop when pulling out the subrack.

CERTIFICATIONS



North America

All locations

+1.763.422.2661

Chat with us:

schroff.nvent.com

Europe

Straubenhardt, Germany

+49.7082.794.0

Betschdorf, France

+33.3.88.90.64.90

Warsaw, Poland

+48.22.209.98.35

Assago, Italy

+39.02.932.7141

Chat with us:

schroff.nvent.com

Asia

Shanghai, China

+86.21.2412.6943

Qingdao, China

+86.532.8771.6101

Singapore

+65.6768.5800

Shin-Yokohama, Japan

+81.45.476.0271

Chat with us:

schroff.nvent.com

Middle East & India

Dubai, United Arab Emirates

+971.4.378.1700

Bangalore, India

+91.80.6715.2001

Istanbul, Turkey

+90.216.250.7374

Chat with us:

schroff.nvent.com



Our powerful portfolio of brands:
nVent.com **CADDY ERICO HOFFMAN RAYCHEM SCHROFF TRACER**

© 2023 nVent. All nVent marks and logos are owned or licensed by nVent Services GmbH or its affiliates. All other trademarks are the property of their respective owners.

nVent reserves the right to change specifications without notice.