

24572-075 RATIOACPRO AIR COMPLETE CASE, DESKTOP, SHIELDED, FRONT TRIM, 3/4 U, 42 HP, 255 MM

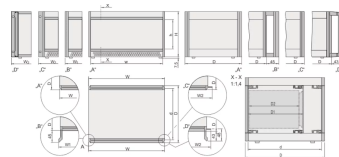
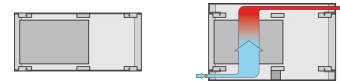
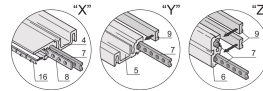
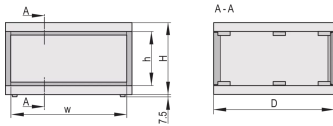
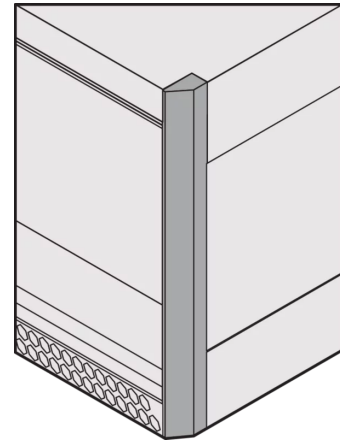
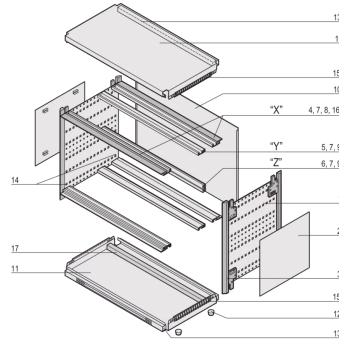

KEY FEATURES

Desktop case pre-configured in accordance with IEC 60297-3-101, for euroboards and backplane with insulation strip

Shielded

Version with cover strips, no visible screws

Case with integrated ventilation (2 x 1/2 U)

Symmetrical design, identical front and rear

Honeycomb grid ventilation in top cover and base plate

For board depth 160 mm, 220 mm, 280 mm, and 340 mm (depending on case depth)

Conforms with DIN EN 62368-1

PRODUCT ATTRIBUTES

Product Type: Case

Product Family: RatiopacPRO AIR

Type: Case for 19" Components

Rack Height: 3 U

Height: 177 mm

Usable Height: 112.3 mm

Rack Width: 42 HP

Width: 235.5 mm

Usable Width: 219 mm

Depth: 255.5 mm

EMC Shielding: Yes

Static Load: 25 kg

Protection Rating: IP20

Front Frame Construction: Side Trim; Horizontal Rails

Cooling Option: Yes

Complies With: IEC 60297-3-101; IEC 60297-3-102; IEEE 1101.1; IEEE 1101.10; IEEE 1101.11

Package Quantity: 1

ADDITIONAL PRODUCT DETAILS

The nVent SCHROFF RatiopacPRO case with EMC shielding provides electronics protection for 19" assemblies. This flexible and robust case is simple to convert from desktop to a 19" rack mount case and includes four different style options. This version of the case provides advanced cooling capabilities and a sleek design for desktop applications.

Modifications (special colours or sizes).

Custom solutions (cut-outs in top cover, base plate or side panels).

Assembly service from 1 piece.

CERTIFICATIONS





North America

All locations

+1.763.422.2661

Chat with us:

schroff.nvent.com

Europe

Straubenhardt, Germany

+49.7082.794.0

Betschdorf, France

+33.3.88.90.64.90

Warsaw, Poland

+48.22.209.98.35

Assago, Italy

+39.02.932.7141

Chat with us:

schroff.nvent.com

Asia

Shanghai, China

+86.21.2412.6943

Qingdao, China

+86.532.8771.6101

Singapore

+65.6768.5800

Shin-Yokohama, Japan

+81.45.476.0271

Chat with us:

schroff.nvent.com

Middle East & India

Dubai, United Arab Emirates

+971.4.378.1700

Bangalore, India

+91.80.6715.2001

Istanbul, Turkey

+90.216.250.7374

Chat with us:

schroff.nvent.com



Our powerful portfolio of brands:
nVent.com **CADDY ERICO HOFFMAN RAYCHEM SCHROFF TRACER**

© 2023 nVent. All nVent marks and logos are owned or licensed by nVent Services GmbH or its affiliates. All other trademarks are the property of their respective owners.

nVent reserves the right to change specifications without notice.