

24575-158 COMPACPRO TIP-UP HANDLE, 3 + 4 U, 63 HP

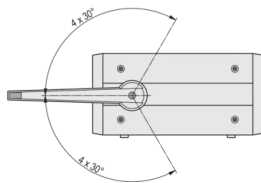
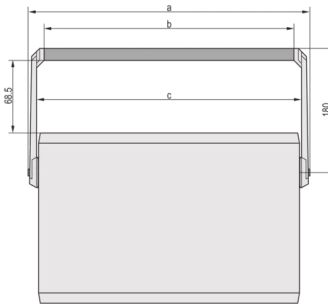

KEY FEATURES

Load-carrying capacity 20 kg

Carrying bar adjustable in increments of 30° by push button

With powder-coated carrying bar

The handle enable a user to have a better view to the front side of the case in case of desktop usage

PRODUCT ATTRIBUTES

Product Type: Handle

Works With: Cases

Handle Type: Tip-up Handle

Rack Width: 63 HP

Material: Aluminum

Package Quantity: 1

Length: 180 mm

ADDITIONAL PRODUCT DETAILS

The tip-up carrying handle can be used for carrying a case or used for tip-up the case.

CERTIFICATIONS



North America

All locations
+1.763.422.2661
Chat with us:
schroff.nvent.com

Europe

Straubenhardt, Germany
+49.7082.794.0
Betschdorf, France
+33.3.88.90.64.90
Warsaw, Poland
+48.22.209.98.35
Assago, Italy
+39.02.932.7141
Chat with us:
schroff.nvent.com

Asia

Shanghai, China
+86.21.2412.6943
Qingdao, China
+86.532.8771.6101
Singapore
+65.6768.5800
Shin-Yokohama, Japan
+81.45.476.0271
Chat with us:
schroff.nvent.com

Middle East & India

Dubai, United Arab Emirates
+971.4.378.1700
Bangalore, India
+91.80.6715.2001
Istanbul, Turkey
+90.216.250.7374
Chat with us:
schroff.nvent.com



Our powerful portfolio of brands:
nVent.com **CADDY ERICO HOFFMAN RAYCHEM SCHROFF TRACER**

© 2023 nVent. All nVent marks and logos are owned or licensed by nVent Services GmbH or its affiliates. All other trademarks are the property of their respective owners.

nVent reserves the right to change specifications without notice.