

24576-106 PROPACPRO COMPLETE DESKTOP CASE, SHIELDED, 3 U, 63 HP, 266 MM

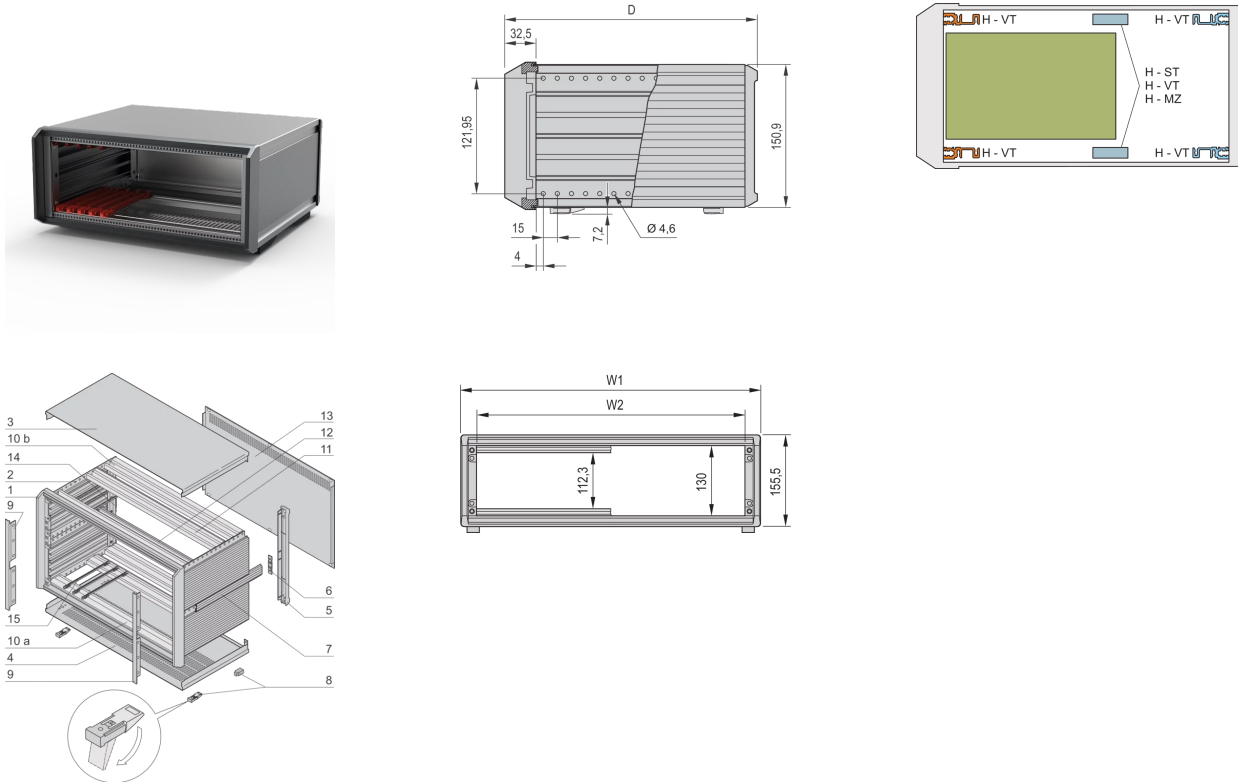

KEY FEATURES

Desktop case, pre-configured in accordance with IEC 60297-3-101 for 19" components

Shielded

Ventilation slots in base plate

Rear panel with vent slots

IP 20 in accordance with IEC 60529

Conforms with DIN EN 62368-1

PRODUCT ATTRIBUTES

Product Type: Case

Product Family: PropacPRO

Type: Case for 19" Components

Rack Height: 3 U

Height: 155.5 mm

Usable Height: 112.3 mm

Rack Width: 63 HP

Width: 363.7 mm

Usable Width: 326 mm

Depth: 266 mm

EMC Shielding: Yes

Static Load: 25 kg

Protection Rating: IP20

Front Frame Construction: Single Piece

Cooling Option: No

Complies With: IEC 60297-3-101

Package Quantity: 1

ADDITIONAL PRODUCT DETAILS

The nVent SCHROFF PropacPRO case provides electronics protection for 19" assemblies such as plug-in units and euroboards. The aluminum die cast frames and profile sidepanels guarantee a robust solution. The case includes EMC shielding as standard.

CERTIFICATIONS

ROHS
COMPLIANT

DIN

North America

All locations

+1.763.422.2661

Chat with us:

schroff.nvent.com

Europe

Straubenhardt, Germany

+49.7082.794.0

Betschdorf, France

+33.3.88.90.64.90

Warsaw, Poland

+48.22.209.98.35

Assago, Italy

+39.02.932.7141

Chat with us:

schroff.nvent.com

Asia

Shanghai, China

+86.21.2412.6943

Qingdao, China

+86.532.8771.6101

Singapore

+65.6768.5800

Shin-Yokohama, Japan

+81.45.476.0271

Chat with us:

schroff.nvent.com

Middle East & India

Dubai, United Arab Emirates

+971.4.378.1700

Bangalore, India

+91.80.6715.2001

Istanbul, Turkey

+90.216.250.7374

Chat with us:

schroff.nvent.com



Our powerful portfolio of brands:
nVent.com **CADDY ERICO HOFFMAN RAYCHEM SCHROFF TRACER**

© 2023 nVent. All nVent marks and logos are owned or licensed by nVent Services GmbH or its affiliates. All other trademarks are the property of their respective owners.

nVent reserves the right to change specifications without notice.