

24812-262 FRAME TYPE PLUG-IN UNIT PRO KIT, PERFORATED COVERS, 1 CONNECTOR, 3 U, 12 HP, 227 MM

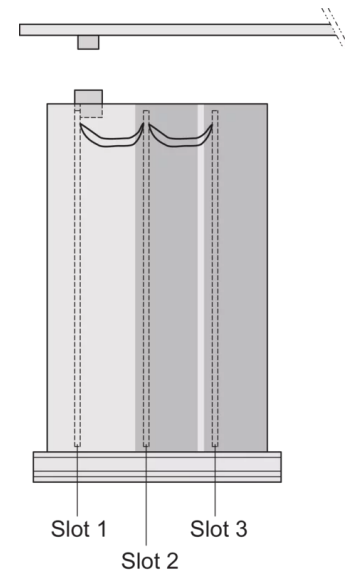
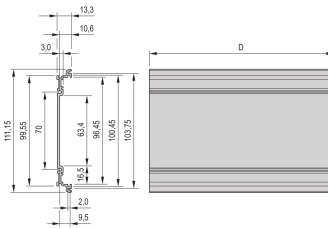
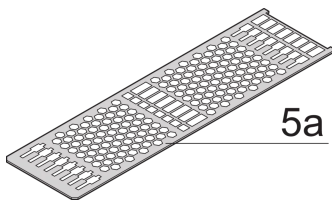
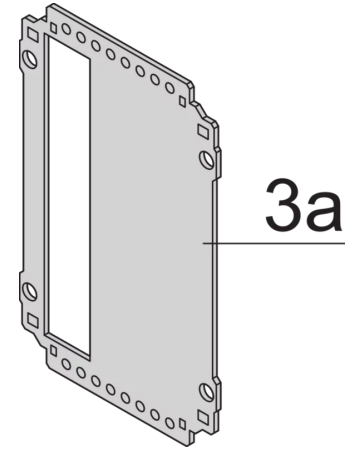
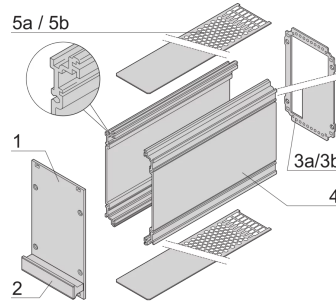

KEY FEATURES

Extruded side panels right and left, with grooves for insertion of a printed circuit board (standard board position is on the left only)

Rear panel with cut-out for single connector (conforms to EN 60603, DIN 41612, construction types: B, C, D, F, H, Q, R, S)

Cover plate with perforation, for guide rails (airflow approx. 60%); please order guide rails separately

PRODUCT ATTRIBUTES

Product Type: Cassette

Type: Frame Type Plug-in Units PRO

Handle Type: Trapezoid

Rack Height: 3 U

Rack Width: 12 HP

Depth: 227 mm

EMC Shielding: No

Rear Panel Type: Single Connector Cut-Out

Cover Plate Type: Cover Plate with Perforation for Guide Rails

Material: Aluminum

Front Finish: Anodized

Rear Finish: Anodized

Cooling: Perforated

ADDITIONAL PRODUCT DETAILS

Frame type plug-in unit, non-shielded, perforated top / bottom cover, rear panel with cutout for one connector.

To fit further boards without rear connector, guide rail (part no. 24812-301) and 'Board fixing from slot 2' (part no. 24812-301 + screw part no. 24560-178) are required, 2 guide rails, 2 rear panel holders and board fixing for slot 1 and one slot-2 are already included.

CERTIFICATIONS



North America

All locations

+1.763.422.2661

Chat with us:

schroff.nvent.com

Europe

Straubenhardt, Germany

+49.7082.794.0

Betschdorf, France

+33.3.88.90.64.90

Warsaw, Poland

+48.22.209.98.35

Assago, Italy

+39.02.932.7141

Chat with us:

schroff.nvent.com

Asia

Shanghai, China

+86.21.2412.6943

Qingdao, China

+86.532.8771.6101

Singapore

+65.6768.5800

Shin-Yokohama, Japan

+81.45.476.0271

Chat with us:

schroff.nvent.com

Middle East & India

Dubai, United Arab Emirates

+971.4.378.1700

Bangalore, India

+91.80.6715.2001

Istanbul, Turkey

+90.216.250.7374

Chat with us:

schroff.nvent.com



Our powerful portfolio of brands:
nVent.com **CADDY ERICO HOFFMAN RAYCHEM SCHROFF TRACER**

© 2023 nVent. All nVent marks and logos are owned or licensed by nVent Services GmbH or its affiliates. All other trademarks are the property of their respective owners.

nVent reserves the right to change specifications without notice.