

24813-007 FRAME TYPE PLUG-IN UNIT PRO KIT, WITH HOOD, SHIELDED VERSION, 3 U, 7 HP, 167 MM

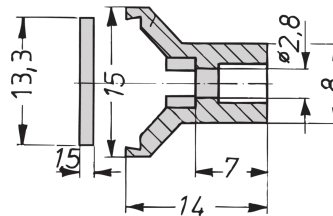
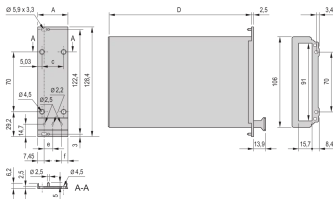
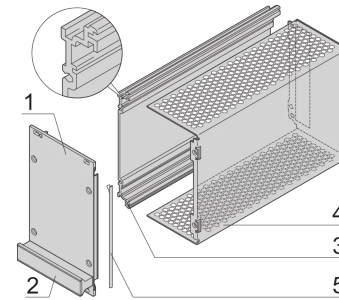
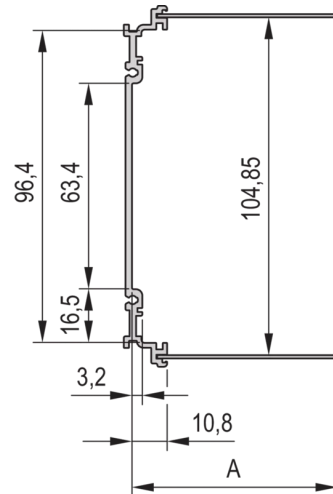

KEY FEATURES

Fits all products conforming to IEC-60297-3-101

Protects a PCB against mechanical damage and discharges electrostatic buildup; for Euroboard formats

Connectors usable under EN 60603-2 (DIN 41612)

PRODUCT ATTRIBUTES

Product Type: Cassette

Type: Frame Type Plug-in Units PRO with Hood

Handle Type: Trapezoid

Rack Height: 3 U

Rack Width: 7 HP

Depth: 167 mm

EMC Shielding: Yes

EMC Gasket Type: Textile

Rear Panel Type: Single Connector Cut-Out

Cover Plate Type: Hood

Material: Aluminum

Front Finish: Anodized

Rear Finish: Conductive

Cooling: Perforated

ADDITIONAL PRODUCT DETAILS

Protects a PCB against mechanical damage and discharges electrostatic buildup; for Euroboard formats.

CERTIFICATIONS



North America

All locations

+1.763.422.2661

Chat with us:

schroff.nvent.com

Europe

Straubenhardt, Germany

+49.7082.794.0

Betschdorf, France

+33.3.88.90.64.90

Warsaw, Poland

+48.22.209.98.35

Assago, Italy

+39.02.932.7141

Chat with us:

schroff.nvent.com

Asia

Shanghai, China

+86.21.2412.6943

Qingdao, China

+86.532.8771.6101

Singapore

+65.6768.5800

Shin-Yokohama, Japan

+81.45.476.0271

Chat with us:

schroff.nvent.com

Middle East & India

Dubai, United Arab Emirates

+971.4.378.1700

Bangalore, India

+91.80.6715.2001

Istanbul, Turkey

+90.216.250.7374

Chat with us:

schroff.nvent.com



Our powerful portfolio of brands:
nVent.com **CADDY ERICO HOFFMAN RAYCHEM SCHROFF TRACER**

© 2023 nVent. All nVent marks and logos are owned or licensed by nVent Services GmbH or its affiliates. All other trademarks are the property of their respective owners.

nVent reserves the right to change specifications without notice.