

30846-865 FRONT PANEL, REFROFIT SHIELDING, 6 U, 2 HP, 2.5 MM, AL, ANODIZED, UNTREATED EDGES

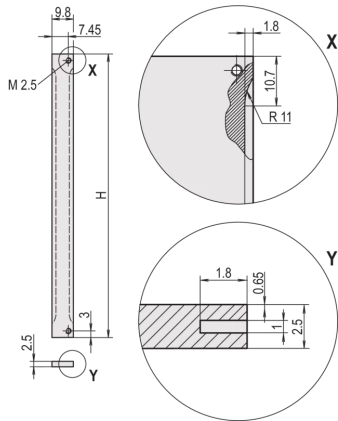

KEY FEATURES

For stainless steel EMC gasket

Al, 2.5 mm, front anodized, conductive

PRODUCT ATTRIBUTES

Type: Front Panel without Handle

Accessory Type: Front panel

Mounting: Screw-on Front

EMC Shielding: No (Retrofittable)

EMC Gasket Type: Stainless Steel

Material: Aluminum

Front Finish: Anodized

Rear Finish: Conductive

Treated Edges: No

Rack Height: 6 U

Rack Width: 2 HP

Height: 261.8 mm

Depth: 2.5 mm

Width: 9.8 mm

Complies With: IEC 60297-3-101; IEEE 1101.1/10

Package Quantity: 5

ADDITIONAL PRODUCT DETAILS

Flat front panel. Shieldable with stainless steel EMC gasket.

Please order fixing material (sleeves, collar screws) separately.

CERTIFICATIONS



North America

All locations
+1.763.422.2661
Chat with us:
schroff.nvent.com

Europe

Straubenhardt, Germany
+49.7082.794.0
Betschdorf, France
+33.3.88.90.64.90
Warsaw, Poland
+48.22.209.98.35
Assago, Italy
+39.02.932.7141
Chat with us:
schroff.nvent.com

Asia

Shanghai, China
+86.21.2412.6943
Qingdao, China
+86.532.8771.6101
Singapore
+65.6768.5800
Shin-Yokohama, Japan
+81.45.476.0271
Chat with us:
schroff.nvent.com

Middle East & India

Dubai, United Arab Emirates
+971.4.378.1700
Bangalore, India
+91.80.6715.2001
Istanbul, Turkey
+90.216.250.7374
Chat with us:
schroff.nvent.com



Our powerful portfolio of brands:
nVent.com **CADDY ERICO HOFFMAN RAYCHEM SCHROFF TRACER**

© 2023 nVent. All nVent marks and logos are owned or licensed by nVent Services GmbH or its affiliates. All other trademarks are the property of their respective owners.

nVent reserves the right to change specifications without notice.