

**30848-331 PLUG-IN UNIT FRONT PANEL, UNSHIELDED, FOR IEL, IET, TYPE 2 HANDLE, 3 U, 8 HP, 2.5 MM, AL, FRONT ANODIZED, REAR CONDUCTIVE**

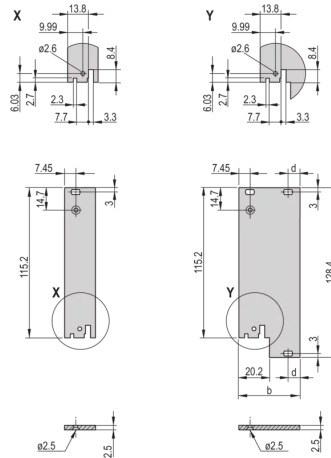

**KEY FEATURES**

Al, 2.5 mm, front anodized, Rear conductive;-trapezium shaped handle,-gray, PPE, UL-94 V-1

Front panel, flat, unshielded, front mounting

For IEL/IET/Trapeziform Type 2 handle

**PRODUCT ATTRIBUTES**

Type: Front Panel for Handle (PIU)

Accessory Type: Front panel

Handle Type: IEL; IET; Trapezoid, Type 2

Mounting: Screw-on Front

EMC Shielding: No

Material: Aluminum

Front Finish: Anodized

Rear Finish: Conductive

Treated Edges: No

Rack Height: 3 U

Width: 40.3 mm

Height: 128.4 mm

Rack Width: 8 HP

Depth: 2.5 mm

Complies With: IEC 60297-3-101; IEEE 1101.1/11

Package Quantity: 5

## ADDITIONAL PRODUCT DETAILS

Flat front panel. It enables an assembly on IEL, IET or the type 2 handle in trapezoid form.

Please take into consideration that deliveries may be carried out in the stated SPQs (SPQ, e.g. 5 pieces, 10 pieces, 50 pieces, etc.). Differing order quantities (e.g. 2 pieces) may be changed to the next possible delivery quantity = Standard Pack Quantity.

## CERTIFICATIONS



### North America

All locations  
+1.763.422.2661  
Chat with us:  
[schroff.nvent.com](https://schroff.nvent.com)

### Europe

Straubenhardt, Germany  
+49.7082.794.0  
Betschdorf, France  
+33.3.88.90.64.90  
Warsaw, Poland  
+48.22.209.98.35  
Assago, Italy  
+39.02.932.7141  
Chat with us:  
[schroff.nvent.com](https://schroff.nvent.com)

### Asia

Shanghai, China  
+86.21.2412.6943  
Qingdao, China  
+86.532.8771.6101  
Singapore  
+65.6768.5800  
Shin-Yokohama, Japan  
+81.45.476.0271  
Chat with us:  
[schroff.nvent.com](https://schroff.nvent.com)

### Middle East & India

Dubai, United Arab Emirates  
+971.4.378.1700  
Bangalore, India  
+91.80.6715.2001  
Istanbul, Turkey  
+90.216.250.7374  
Chat with us:  
[schroff.nvent.com](https://schroff.nvent.com)



Our powerful portfolio of brands:  
[nVent.com](https://nVent.com) **CADDY ERICO HOFFMAN RAYCHEM SCHROFF TRACER**

© 2023 nVent. All nVent marks and logos are owned or licensed by nVent Services GmbH or its affiliates. All other trademarks are the property of their respective owners.

nVent reserves the right to change specifications without notice.