

## 30860-513 MULTIPACPRO COVER PLATE, PERFORATED, DEPTH 400 MM

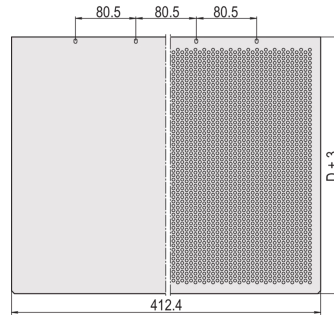
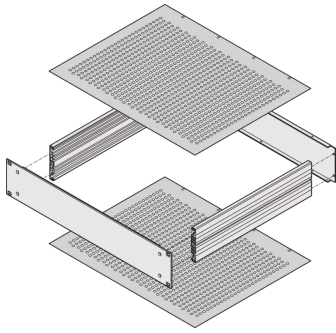

### KEY FEATURES

Perforated cover plates can be used as either top or base plates; inserted into base structure

Cover plate, perforated, hole diameter 4 mm, perforation ratio 58 %

### PRODUCT ATTRIBUTES

Product Type: Cover Plate

Product Family: MultipacPRO

Type: Perforated

Depth: 400 mm

Package Quantity: 1

### ADDITIONAL PRODUCT DETAILS

Cover plates perforated version will close the 19" chassis on top and bottom side. The hole diameter is 4 mm, perforation ratio 58 %.

### CERTIFICATIONS



### North America

All locations

+1.763.422.2661

Chat with us:

[schroff.nvent.com](https://schroff.nvent.com)

### Europe

Straubenhardt, Germany

+49.7082.794.0

Betschdorf, France

+33.3.88.90.64.90

Warsaw, Poland

+48.22.209.98.35

Assago, Italy

+39.02.932.7141

Chat with us:

[schroff.nvent.com](https://schroff.nvent.com)

### Asia

Shanghai, China

+86.21.2412.6943

Qingdao, China

+86.532.8771.6101

Singapore

+65.6768.5800

Shin-Yokohama, Japan

+81.45.476.0271

Chat with us:

[schroff.nvent.com](https://schroff.nvent.com)

### Middle East & India

Dubai, United Arab Emirates

+971.4.378.1700

Bangalore, India

+91.80.6715.2001

Istanbul, Turkey

+90.216.250.7374

Chat with us:

[schroff.nvent.com](https://schroff.nvent.com)



Our powerful portfolio of brands:  
[nVent.com](https://nVent.com) **CADDY ERICO HOFFMAN RAYCHEM SCHROFF TRACER**

© 2023 nVent. All nVent marks and logos are owned or licensed by nVent Services GmbH or its affiliates. All other trademarks are the property of their respective owners.

nVent reserves the right to change specifications without notice.