

**34812-103 FRAME TYPE PLUG-IN UNIT SIDE PLATE FOR CORNER PROFILE, 3 U,
167 MM PCB**

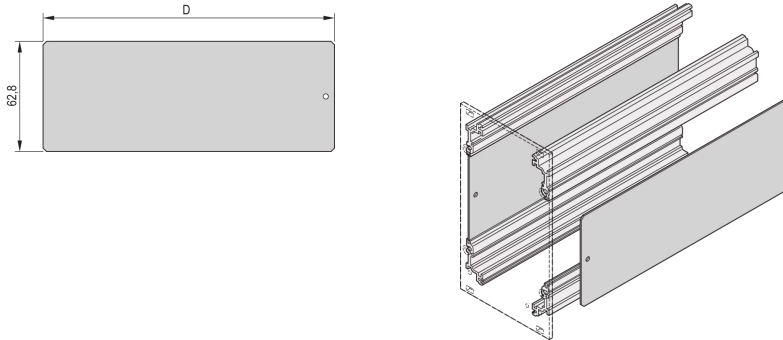

KEY FEATURES

Side Panel of plug-in unit is constructed with two components

Plate is inserted between two corner profiles

Integrated lateral groove in corner profile to accept a PCB

PRODUCT ATTRIBUTES

Product Type: Cover

Works With: Cassettes

Rack Height: 3 U

Depth: 167 mm

Length: 160 mm

Package Quantity: 5

ADDITIONAL PRODUCT DETAILS

The side Panels can be inserted into the groove of the corner profile.

Please order corner profiles for building a side Panel separately.

Please take into consideration that deliveries may be carried out in the stated SPQs (SPQ, e.g. 5 pieces, 10 pieces, 50 pieces, etc.). Differing order quantities (e.g. 2 pieces) may be changed to the next possible delivery quantity = Standard Pack Quantity.



North America

All locations
+1.763.422.2661
Chat with us:
schroff.nvent.com

Europe

Straubenhardt, Germany
+49.7082.794.0
Betschdorf, France
+33.3.88.90.64.90
Warsaw, Poland
+48.22.209.98.35
Assago, Italy
+39.02.932.7141
Chat with us:
schroff.nvent.com

Asia

Shanghai, China
+86.21.2412.6943
Qingdao, China
+86.532.8771.6101
Singapore
+65.6768.5800
Shin-Yokohama, Japan
+81.45.476.0271
Chat with us:
schroff.nvent.com

Middle East & India

Dubai, United Arab Emirates
+971.4.378.1700
Bangalore, India
+91.80.6715.2001
Istanbul, Turkey
+90.216.250.7374
Chat with us:
schroff.nvent.com



Our powerful portfolio of brands:
nVent.com **CADDY ERICO HOFFMAN RAYCHEM SCHROFF TRACER**