

34813-701 FRAME TYPE PLUG-IN UNIT EXTRUDED SIDE PANEL, WITH COOLING FINS, RIGHT, 6 U, 220 MM

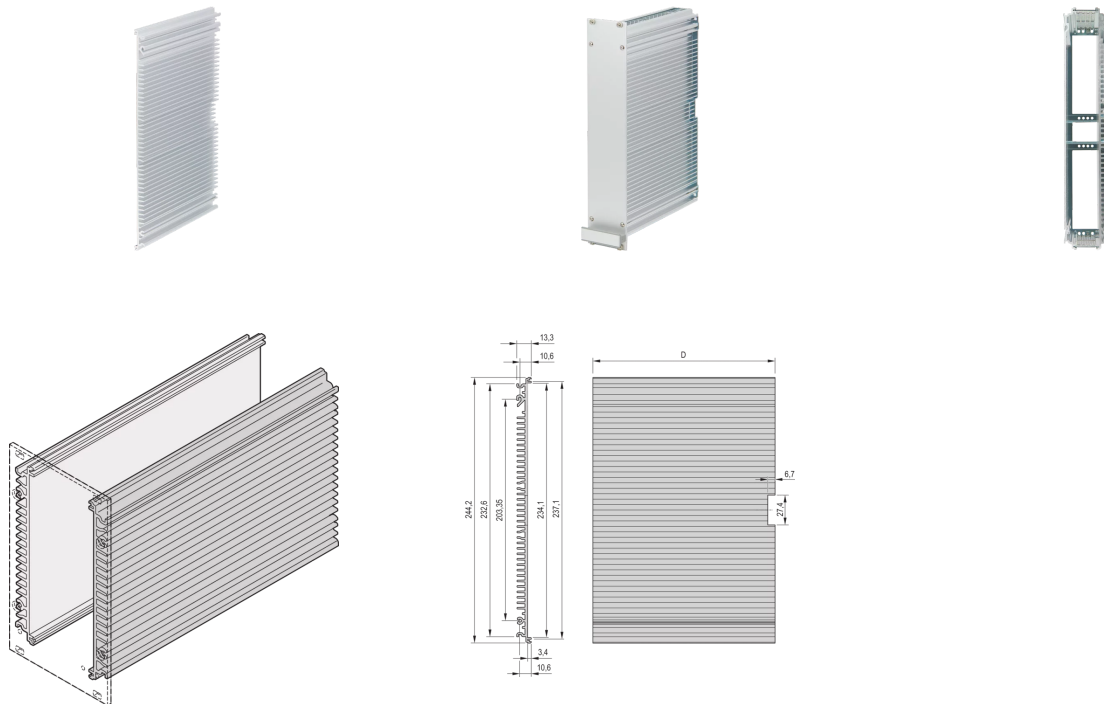

KEY FEATURES

The external dimensions (8 ... 42 HP) are unchanged; the available space inside is reduced widthwise by the cooling Fins

With 10 W installed heat dissipation the interior temperature in the module is reduced by about 5 °C

Side Panel with cooling Fins for a frame-type plug-in unit (Al extrusion).-The surface is 65% greater than with a side Panel without cooling Fins

PRODUCT ATTRIBUTES

Product Type: Side Panel

Type: Side Panel

Rack Height: 6 U

Package Quantity: 10

Depth: 227 mm

ADDITIONAL PRODUCT DETAILS

Side Panel for frame type plug-in unit, extruded with cooling Fins. The cooling Fins enable additional heat dissipation via the cooling Fins.

Side Panels with and without cooling Fins can be combined. Frame type plug-in unit consists of: 2 side Panels, front Panel with handle, rear Panel, cover plate, base plate, fixing kit.

Please take into consideration that deliveries may be carried out in the stated SPQs (SPQ, e.g. 5 pieces, 10 pieces, 50 pieces, etc.). Differing order quantities (e.g. 2 pieces) may be changed to the next possible delivery quantity = Standard Pack Quantity.

CERTIFICATIONS



North America

All locations
+1.763.422.2661
Chat with us:
schroff.nvent.com

Europe

Straubenhardt, Germany
+49.7082.794.0
Betschdorf, France
+33.3.88.90.64.90
Warsaw, Poland
+48.22.209.98.35
Assago, Italy
+39.02.932.7141
Chat with us:
schroff.nvent.com

Asia

Shanghai, China
+86.21.2412.6943
Qingdao, China
+86.532.8771.6101
Singapore
+65.6768.5800
Shin-Yokohama, Japan
+81.45.476.0271
Chat with us:
schroff.nvent.com

Middle East & India

Dubai, United Arab Emirates
+971.4.378.1700
Bangalore, India
+91.80.6715.2001
Istanbul, Turkey
+90.216.250.7374
Chat with us:
schroff.nvent.com



Our powerful portfolio of brands:
nVent.com **CADDY ERICO HOFFMAN RAYCHEM SCHROFF TRACER**

© 2023 nVent. All nVent marks and logos are owned or licensed by nVent Services GmbH or its affiliates. All other trademarks are the property of their respective owners.

nVent reserves the right to change specifications without notice.