

34813-708 FRAME TYPE PLUG-IN UNIT REAR PANEL, PLAIN, 6 U, 8 HP

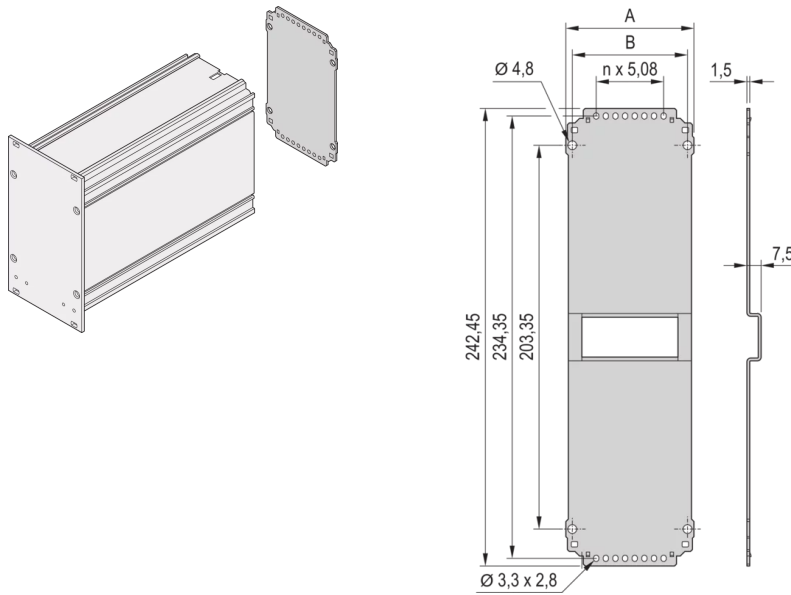

KEY FEATURES

Rear Panel for bolting to extruded side Panel or side Panel rear angle

PRODUCT ATTRIBUTES

Product Type: Side Panel

Type: Rear Panel

Rack Height: 6 U

Rack Width: 8 HP

Material: Steel

Package Quantity: 5

Depth: 7.5 mm

Finish: Zinc Plated

Height: 242.45 mm

Width: 37.04 mm

ADDITIONAL PRODUCT DETAILS

Rear Panel for frame type plug-in unit, without cut-out. This enable a user modify the Panel for individual connectors.

Screws for fixing the rear Panel to the module are included in the item 'Mounting kit for five plug-in units', part no. 24812-100. The screw alone (100 pieces) is part no. 24812-501. The rear Panel retainer for wide modules for cover plates (solid or for guide rails) are available as a kit (10 retainers + 10 screws), part no. 24812-401. Alternatively the rear Panel retainer (part no. 24812-402) and the screw (part no. 24560-148) 100-pieces can be ordered individually.

Please take into consideration that deliveries may be carried out in the stated SPQs (SPQ, e.g. 5 pieces, 10 pieces, 50 pieces, etc.). Differing order quantities (e.g. 2 pieces) may be changed to the next possible delivery quantity = Standard Pack Quantity.

CERTIFICATIONS



North America

All locations
+1.763.422.2661
Chat with us:
schroff.nvent.com

Europe

Straubenhardt, Germany
+49.7082.794.0
Betschdorf, France
+33.3.88.90.64.90
Warsaw, Poland
+48.22.209.98.35
Assago, Italy
+39.02.932.7141
Chat with us:
schroff.nvent.com

Asia

Shanghai, China
+86.21.2412.6943
Qingdao, China
+86.532.8771.6101
Singapore
+65.6768.5800
Shin-Yokohama, Japan
+81.45.476.0271
Chat with us:
schroff.nvent.com

Middle East & India

Dubai, United Arab Emirates
+971.4.378.1700
Bangalore, India
+91.80.6715.2001
Istanbul, Turkey
+90.216.250.7374
Chat with us:
schroff.nvent.com



Our powerful portfolio of brands:
nVent.com **CADDY ERICO HOFFMAN RAYCHEM SCHROFF TRACER**

© 2023 nVent. All nVent marks and logos are owned or licensed by nVent Services GmbH or its affiliates. All other trademarks are the property of their respective owners.

nVent reserves the right to change specifications without notice.