

60110-223 SOCKET STRIP, UTE, 15 SOCKETS

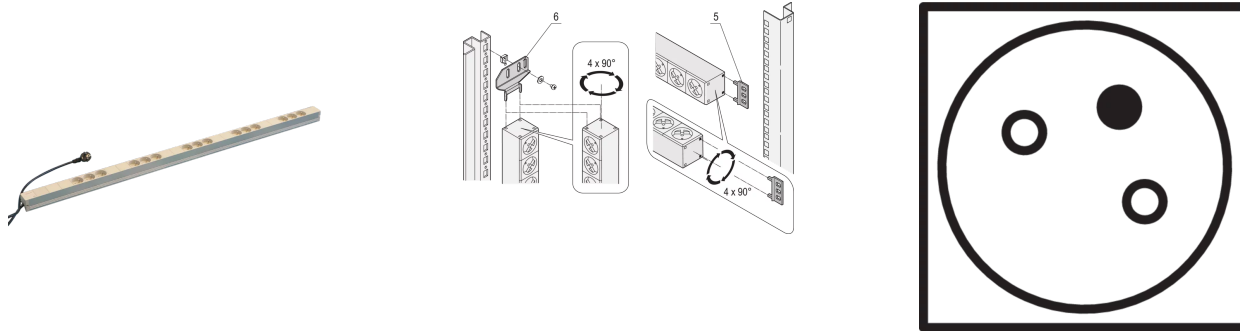

KEY FEATURES

230 V, 16 A

In accordance with NFC 61-303

Socket strip with UTE sockets

Mounting height 1 U

Horizontal or vertical mounting

Connecting cable 2 m, with SCHUKO/UTE plug

Socket strips can be rotated through all four directions (in 90° increments) during installation

PRODUCT ATTRIBUTES

Socket Type: UTE

Number of Sockets: 15

Color: Grey

With Switch: No

Length: 1202 mm

Voltage AC: 230 V

Depth: 44 mm

ADDITIONAL PRODUCT DETAILS

Modular, compact PDU with many function elements. Using a 1 U by 1 U aluminum chassis the PDU can easily be integrated in a rack with UTE outlets.

Please order bracket for vertical mounting separately.

CERTIFICATIONS



North America

All locations
+1.763.422.2661
Chat with us:
schroff.nvent.com

Europe

Straubenhardt, Germany
+49.7082.794.0
Betschdorf, France
+33.3.88.90.64.90
Warsaw, Poland
+48.22.209.98.35
Assago, Italy
+39.02.932.7141
Chat with us:
schroff.nvent.com

Asia

Shanghai, China
+86.21.2412.6943
Qingdao, China
+86.532.8771.6101
Singapore
+65.6768.5800
Shin-Yokohama, Japan
+81.45.476.0271
Chat with us:
schroff.nvent.com

Middle East & India

Dubai, United Arab Emirates
+971.4.378.1700
Bangalore, India
+91.80.6715.2001
Istanbul, Turkey
+90.216.250.7374
Chat with us:
schroff.nvent.com



Our powerful portfolio of brands:
nVent.com **CADDY ERICO HOFFMAN RAYCHEM SCHROFF TRACER**

© 2023 nVent. All nVent marks and logos are owned or licensed by nVent Services GmbH or its affiliates. All other trademarks are the property of their respective owners.

nVent reserves the right to change specifications without notice.