

24567-474 EUROPACPRO 19" SUBRACK KIT FOR BACKPLANE, HEAVY, SHIELDED, FRONT HANDLE, 6 U, 355 MM

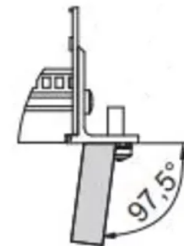
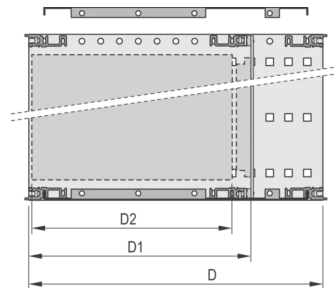
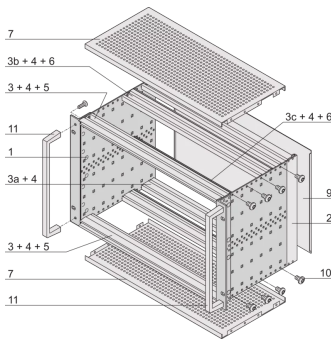
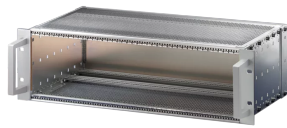

KEY FEATURES

Subrack with side panel type H ("Heavy"), 19" bracket is firmly fixed to side panel (tox-cold welded) and includes handles

Modifications such as cutouts, different finishes or dimensions available

Supplied as space-saving flat-pack

Aluminum construction

Horizontal rail type "Heavy"

Rear horizontal rail for backplane mounting with insulation strip

EMC of approximately 40 dB at 1 GHz, 30 dB at 2 GHz, assuming that the front is covered with shielded front panels, testing in accordance with VG 95373 part 15

Shock and vibration tested to the German "Bahn" standards BN 411002, BN 411003

Internal and external dimensions in accordance with: IEC 60297-3-100, -101, IEEE 1101.1

IP 20, in accordance with IEC 60529

PRODUCT ATTRIBUTES

Product Type: Subrack/Chassis

Rack Height: 6 U

Rack Width: 84 HP

Depth: 355 mm

For Mounting: Backplane

Board Depth: 160 mm; 220 mm; 280 mm / 160 mm; 220 mm; 280 mm / 160 mm; 220 mm; 280 mm

EMC Shielding: Yes

EMC Gasket Type: Textile

Static Load: 15 kg

Shock and Vibration Tolerance: 5 g (force)

Handle Included: Yes

Mounting: Rack

Complies With: IEC 60297-3-103

Package Quantity: 1

ADDITIONAL PRODUCT DETAILS

EMC Shielded subrack for backplane mounting, heavy version with tox welded side panels and front handle.

Individual configuration: broad range of variants in height, width and depth; guide rails for a wide variety of applications; interior options; accessories and mounting material.

CERTIFICATIONS



North America

All locations

+1.763.422.2661

Chat with us:

schroff.nvent.com

Europe

Straubenhardt, Germany

+49.7082.794.0

Betschdorf, France

+33.3.88.90.64.90

Warsaw, Poland

+48.22.209.98.35

Assago, Italy

+39.02.932.7141

Chat with us:

schroff.nvent.com

Asia

Shanghai, China

+86.21.2412.6943

Qingdao, China

+86.532.8771.6101

Singapore

+65.6768.5800

Shin-Yokohama, Japan

+81.45.476.0271

Chat with us:

schroff.nvent.com

Middle East & India

Dubai, United Arab Emirates

+971.4.378.1700

Bangalore, India

+91.80.6715.2001

Istanbul, Turkey

+90.216.250.7374

Chat with us:

schroff.nvent.com



Our powerful portfolio of brands:
nVent.com **CADDY ERICO HOFFMAN RAYCHEM SCHROFF TRACER**

© 2023 nVent. All nVent marks and logos are owned or licensed by nVent Services GmbH or its affiliates. All other trademarks are the property of their respective owners.

nVent reserves the right to change specifications without notice.