

24572-606 RATIOACPRO EMC FRONT PANEL, SLOTTED, SHIELDED, 3 U, 84 HP, 2.5 MM, AL, FRONT ANODIZED, REAR CONDUCTIVE

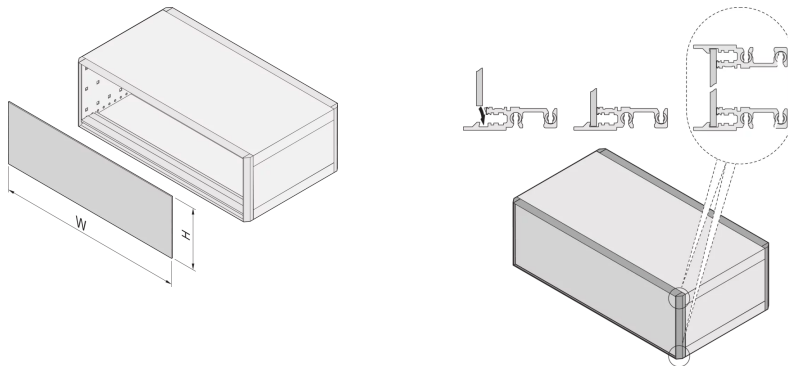

KEY FEATURES

Fixing does not require screws

Special horizontal rails cover the edges of the front panel (top and bottom) and prevent bowing of the front panel

PRODUCT ATTRIBUTES

Accessory Type: Front panel

Material: Aluminum

Front Finish: Anodized

Rear Finish: Conductive

Treated Edges: No

Rack Height: 3 U

Rack Width: 84 HP

Height: 128.4 mm

Depth: 2.5 mm

Width: 426.4 mm

Package Quantity: 1

ADDITIONAL PRODUCT DETAILS

The EMC front panel can be inserted in special horizontal rails with an elevation. No screws are needed for the fixing. The design enable a users to use a front foil.

To obtain a shielded case, all EMC sealings must be fitted (front panel/rear panel - side panel; side panel - cover plate; front panel/rear panel - horizontal rail; horizontal rail - horizontal rail).

CERTIFICATIONS



North America

All locations
+1.763.422.2661
Chat with us:
schroff.nvent.com

Europe

Straubenhardt, Germany
+49.7082.794.0
Betschdorf, France
+33.3.88.90.64.90
Warsaw, Poland
+48.22.209.98.35
Assago, Italy
+39.02.932.7141
Chat with us:
schroff.nvent.com

Asia

Shanghai, China
+86.21.2412.6943
Qingdao, China
+86.532.8771.6101
Singapore
+65.6768.5800
Shin-Yokohama, Japan
+81.45.476.0271
Chat with us:
schroff.nvent.com

Middle East & India

Dubai, United Arab Emirates
+971.4.378.1700
Bangalore, India
+91.80.6715.2001
Istanbul, Turkey
+90.216.250.7374
Chat with us:
schroff.nvent.com



Our powerful portfolio of brands:
nVent.com **CADDY ERICO HOFFMAN RAYCHEM SCHROFF TRACER**

© 2023 nVent. All nVent marks and logos are owned or licensed by nVent Services GmbH or its affiliates. All other trademarks are the property of their respective owners.

nVent reserves the right to change specifications without notice.