

21630-176 RACKCHILLER IN-ROW COOLER GANGING KIT FOR VARISTAR CP, 38 U, 300 MM WIDTH, WITH 100 MM PLINTH

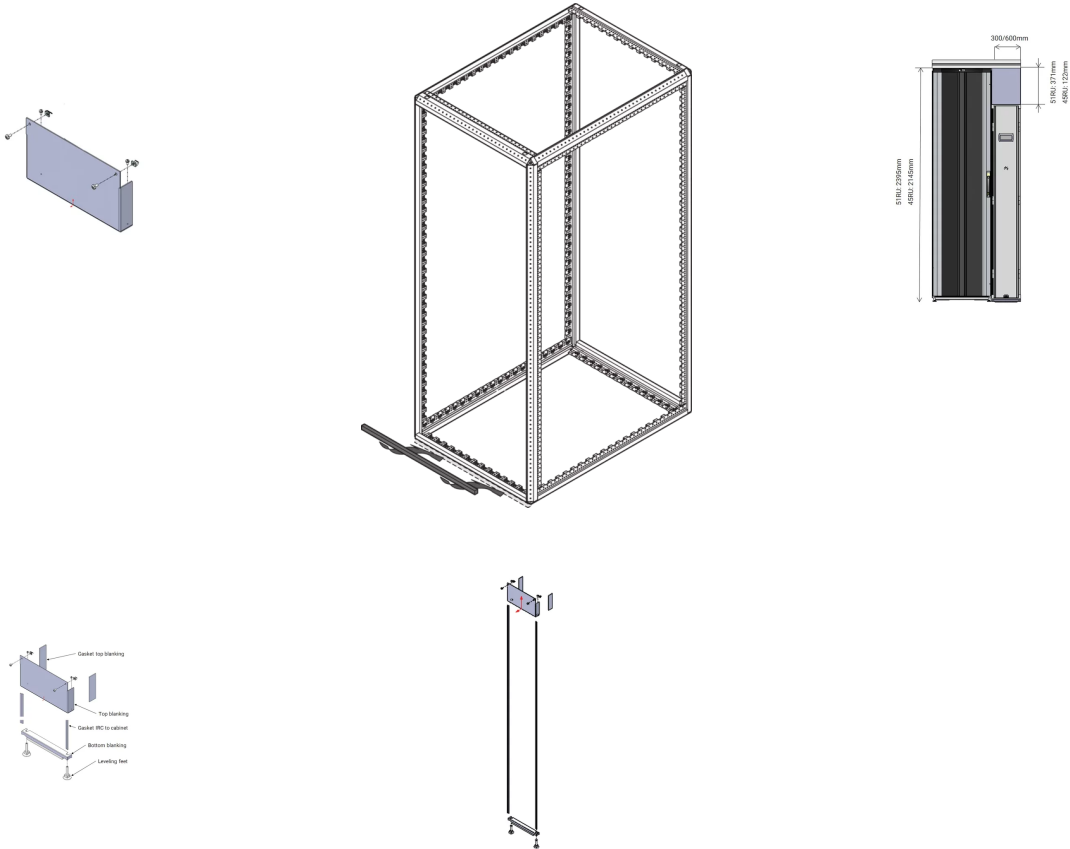

KEY FEATURES

Seamlessly integrates the Rack-Chiller In-Row into aisle containments

Including plinth, levelling feet and top blanking panel

PRODUCT ATTRIBUTES

Product Type: Mounting Kit

Product Family: RackChiller

Works With: Aisle Containment

Material: Steel

Color: Black Grey

Color Code: RAL 7021

Rack Height: 38 U

Width: 300 mm

ADDITIONAL PRODUCT DETAILS

The RackChiller In-Row Ganging kit allows for integration of the cooler into Proline or Varistar aisle containments. The included levelling feet, plinth and top blanking panel assure seamless look while providing best sealing properties of the aisle containment. The kit is available in different variations, depending on the cooler and racks used.

North America

All locations

+1.763.422.2661

Chat with us:

schroff.nvent.com

Europe

Straubenhardt, Germany

+49.7082.794.0

Betschdorf, France

+33.3.88.90.64.90

Warsaw, Poland

+48.22.209.98.35

Assago, Italy

+39.02.932.7141

Chat with us:

schroff.nvent.com

Asia

Shanghai, China

+86.21.2412.6943

Qingdao, China

+86.532.8771.6101

Singapore

+65.6768.5800

Shin-Yokohama, Japan

+81.45.476.0271

Chat with us:

schroff.nvent.com

Middle East & India

Dubai, United Arab Emirates

+971.4.378.1700

Bangalore, India

+91.80.6715.2001

Istanbul, Turkey

+90.216.250.7374

Chat with us:

schroff.nvent.com



Our powerful portfolio of brands:
nVent.com **CADDY ERICO HOFFMAN RAYCHEM SCHROFF TRACER**

© 2024 nVent. All nVent marks and logos are owned or licensed by nVent Services GmbH or its affiliates. All other trademarks are the property of their respective owners.

nVent reserves the right to change specifications without notice.