

24582-225 RATIOACPRO STYLE, FRONT AND REAR TRIM, SCREWLESS FRONT, 2 U, 42 HP, 295,5 MM

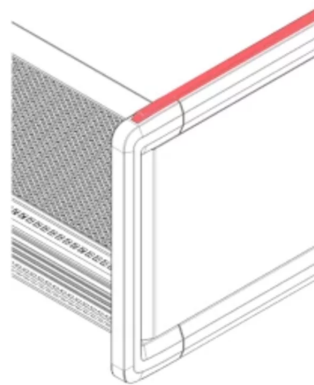

KEY FEATURES

Desktop case with protective frame design and rubber strips on the top and bottom for a secure stand and with integrated stacking function

Case for 19" components (guide rails) or proprietary components (mounting plate).

To establish EMC-shielding, additional components need to be added to the enclosure.

Front side for front panel mounting without screws and rear side prepared for standard front panel mounting.

Perforated bottom cover for air-cooling

No visible screws; cladding parts removable without tools

For board depth 160 mm, 220 mm, 280 mm and 340 mm (depending on case depth)

PRODUCT ATTRIBUTES

Product Type: Case

Product Family: RatiopacPRO Style

Type: Case for Individual Electronic Components

Rack Height: 2 U

Height: 112 mm

Usable Height: 67.9 mm

Rack Width: 42 HP

Width: 247.5 mm

Usable Width: 213.9 mm

Depth: 354 mm

EMC Shielding: No (Retrofittable)

Static Load: 25 kg

Protection Rating: IP30

Front Frame Construction: Side Trim; Horizontal Rails

Cooling Option: Yes

Complies With: IEC 60297-3-101; IEC 60297-3-102; IEEE 1101.1; IEEE 1101.10; IEEE 1101.11

Package Quantity: 1

ADDITIONAL PRODUCT DETAILS

The versatile RatiopacPRO Style desktop case features a protective frame design, rubber strips, and various configuration options.

The Front and Rear Trims with Top & Bottom Rubber Strip option provides connector safeguarding and integrated stacking capability. The Circulated Rubber Strip design protects corner and is ideal for smaller mobile cases. For larger equipment, the Front Handle offers convenient carrying and rear connector protection.

Designed for 19" components with guide rails or proprietary components with a mounting plate, RatiopacPRO Style caters to your specific requirements.

For custom configurations (colors, sizes, etc.), please visit our online configurator (<https://configurators.schroff.biz/ratiopacpro-style>).

Modification service for customer specific versions on request (special colours, sizes, cut-outs, etc.).

Assembly service from lotsize 1.

North America

All locations

+1.763.422.2661

Chat with us:

schroff.nvent.com

Europe

Straubenhardt, Germany

+49.7082.794.0

Betschdorf, France

+33.3.88.90.64.90

Warsaw, Poland

+48.22.209.98.35

Assago, Italy

+39.02.932.7141

Chat with us:

schroff.nvent.com

Asia

Shanghai, China

+86.21.2412.6943

Qingdao, China

+86.532.8771.6101

Singapore

+65.6768.5800

Shin-Yokohama, Japan

+81.45.476.0271

Chat with us:

schroff.nvent.com

Middle East & India

Dubai, United Arab Emirates

+971.4.378.1700

Bangalore, India

+91.80.6715.2001

Istanbul, Turkey

+90.216.250.7374

Chat with us:

schroff.nvent.com



Our powerful portfolio of brands:
nVent.com **CADDY ERICO HOFFMAN RAYCHEM SCHROFF TRACER**

© 2024 nVent. All nVent marks and logos are owned or licensed by nVent Services GmbH or its affiliates. All other trademarks are the property of their respective owners.

nVent reserves the right to change specifications without notice.