

28230-110 NOVASTAR CABINET FRAME, UNIVERSAL HEAVY-DUTY, 16 U 553W
600D

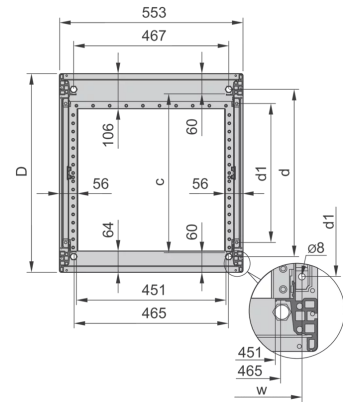

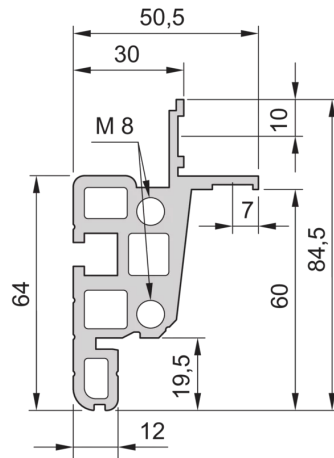
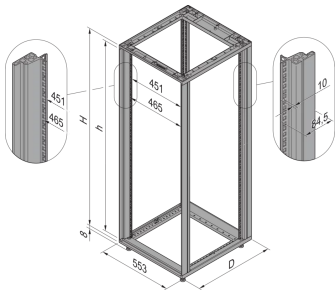
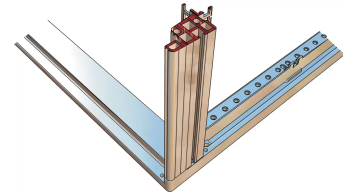
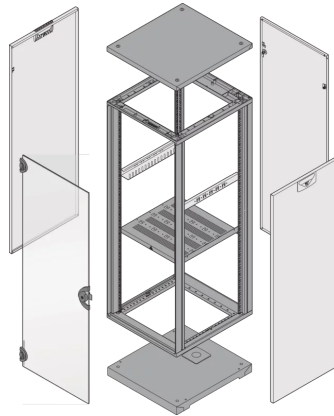
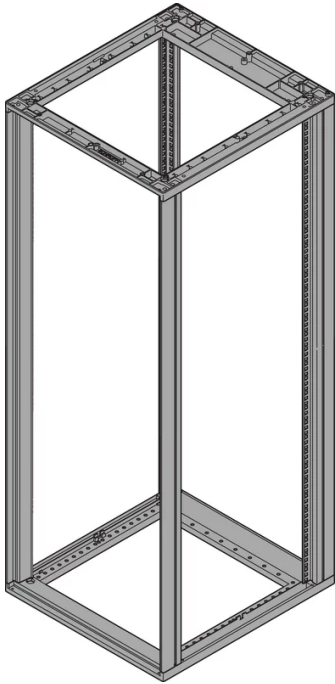
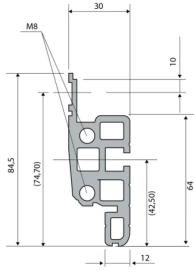

KEY FEATURES

Novastar Frame, Universal Heavy-Duty

Aluminium profile, RAL 7021, including grounding

Static load-carrying capacity 400 kg

PRODUCT ATTRIBUTES

Product Type: Cabinet/Rack Frame

Product Family: Novastar

Type: Universal

Material: Aluminum

Frame Material: Aluminum

Color: Black Grey

Color Code: RAL 7021

Rack Height: 16 U

Height: 767 mm

Width: 553 mm

Depth: 600 mm

Static Load: 400 kg

ADDITIONAL PRODUCT DETAILS

Aesthetic aluminum extruded frame with 400 kg static load capacity. 19" upright built into the frame.

CERTIFICATIONS



North America

All locations

+1.763.422.2661

Chat with us:

schroff.nvent.com

Europe

Straubenhardt, Germany

+49.7082.794.0

Betschdorf, France

+33.3.88.90.64.90

Warsaw, Poland

+48.22.209.98.35

Assago, Italy

+39.02.932.7141

Chat with us:

schroff.nvent.com

Asia

Shanghai, China

+86.21.2412.6943

Qingdao, China

+86.532.8771.6101

Singapore

+65.6768.5800

Shin-Yokohama, Japan

+81.45.476.0271

Chat with us:

schroff.nvent.com

Middle East & India

Dubai, United Arab Emirates

+971.4.378.1700

Bangalore, India

+91.80.6715.2001

Istanbul, Turkey

+90.216.250.7374

Chat with us:

schroff.nvent.com



Our powerful portfolio of brands:
nVent.com **CADDY ERICO HOFFMAN RAYCHEM SCHROFF TRACER**

© 2024 nVent. All nVent marks and logos are owned or licensed by nVent Services GmbH or its affiliates. All other trademarks are the property of their respective owners.

nVent reserves the right to change specifications without notice.