

Bottom view

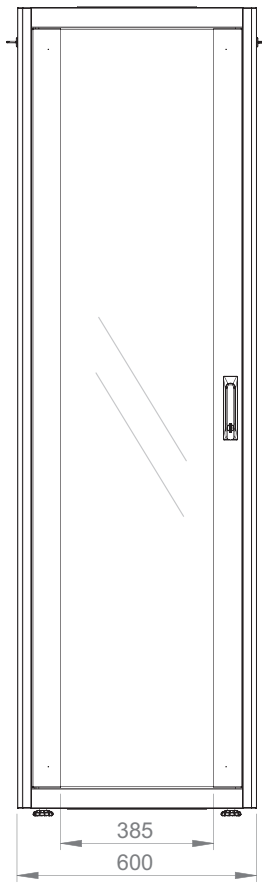

Front view

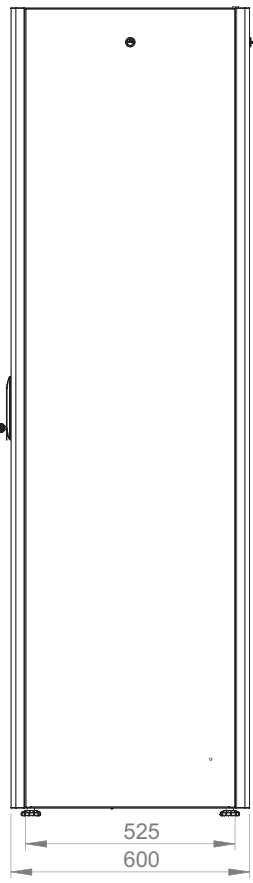

Side view

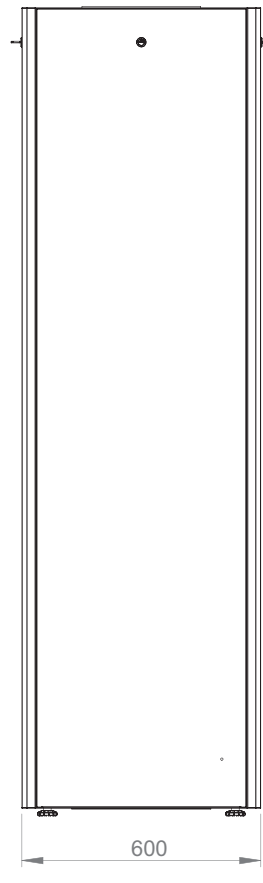

Rear view

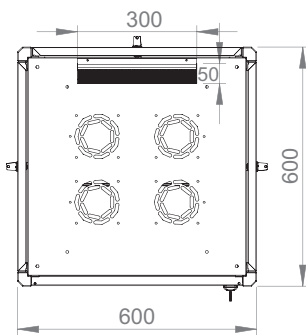

Top view

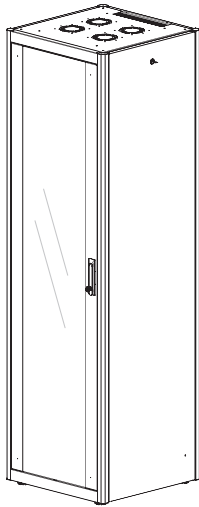

Isometric view

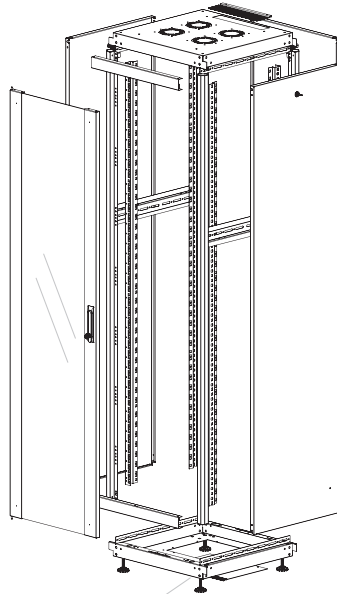

Exploded view

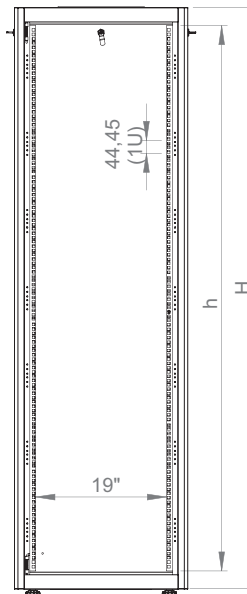

Dimensions in width and height

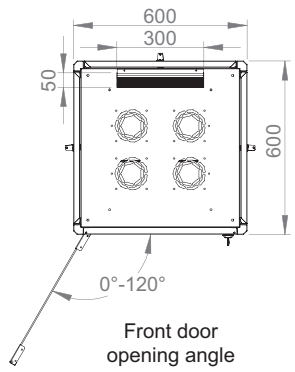
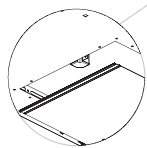

Front door opening angle

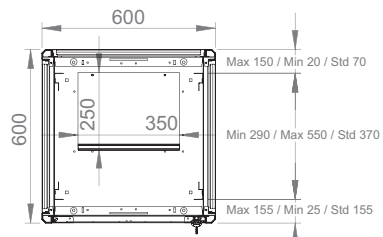

Max/std/min equipment mounting distance

	h	H
22U	978 mm	1125 mm
26U	1155 mm	1300 mm
32U	1422 mm	1560 mm
36U	1600 mm	1744 mm
42U	1867 mm	2010 mm
47U	2089 mm	2236 mm